

# REDD

Reducing Emissions from Deforestation and  
forest Degradation and the Role of Conservation,  
Sustainable Management of Forests and Enhancement

## -plus

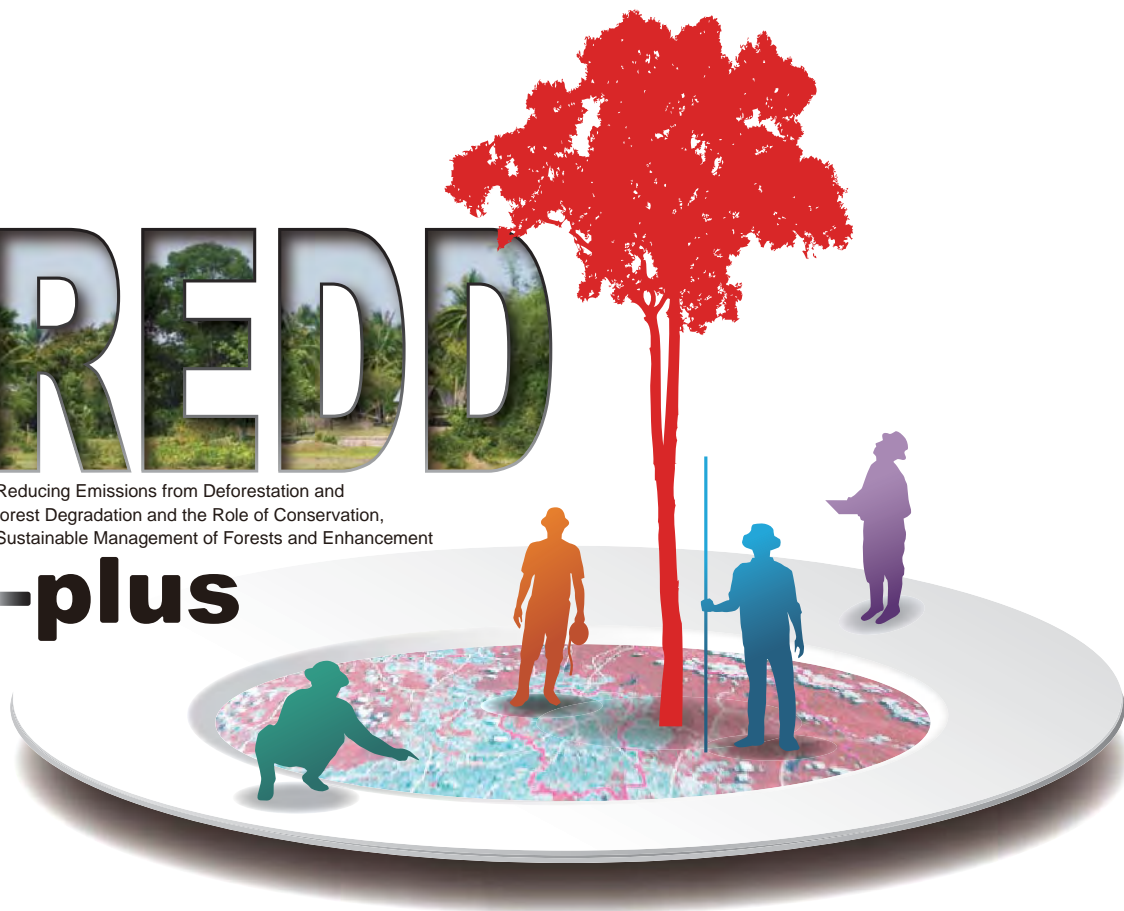

# COOKBOOK

HOW TO MEASURE AND MONITOR FOREST CARBON



# Preface

Deforestation and forest degradation in developing countries result in 20 percent of global anthropogenic CO<sub>2</sub> emissions, and are the major source of CO<sub>2</sub> emissions after the fossil fuels usage. In light of this, the establishment of REDD-plus has been discussed as an international framework to reduce emissions from deforestation and forest degradation. Initially, REDD-plus was just one item on the agenda concerning future climate change mitigation under the United Nations Framework Convention on Climate Change (UNFCCC), but as UNFCCC discussions have proceeded, REDD-plus has been modified to include bilateral and multilateral activities by Parties to the Convention and private activities.

The basic concept of REDD-plus is to provide economic incentives such as funding or credits to developing countries for REDD activities (reducing emissions from deforestation and forest degradation) and "plus" activities (reducing CO<sub>2</sub> emissions and CO<sub>2</sub> levels in the atmosphere by carbon sequestration). Thus, in order to estimate the changes in the amount of carbon stored in forests, monitoring using scientific approach is essential.

This Cookbook is an easy-to-understand technical manual which provide basic knowledge and techniques required for REDD-plus with the main focus on the forest carbon monitoring methods. It comprises of four parts: "Introduction", "Planning", "Technical", and "Reference Guide". "Introduction" is designed for the policy makers and their partner organizations working for the introduction of REDD-plus at national/sub-national level, "Planning" is intended for the planners and managers of REDD-plus implementing organizations/countries working on REDD-plus at national/sub-national level, and "Technical" for the experts who work on the REDD-plus activities at national/sub-national level. "Reference Guide" provides references of useful documents which assist users to have a better understanding of "Introduction" and "Planning". In order to have a better understanding of REDD-plus, it is recommended to read "Introduction" in conjunction with "Planning", or "Planning" with "Technical".

In the sections "Introduction", "Planning", and "Technical", knowledge and techniques required to address REDD-plus are compiled in units called "recipe". Users can easily go through the items in each recipe to in-depth recipe or references in accordance with the "Flow Chart". "Reference Guide" aims to provide users with useful information by proposing or showing examples that can be used as a guide when exploring realistic and practical measures for designing and implementing the projects and programs.

This Cookbook is an effort of the REDD Research and Development Center in hopes of contributing to promote REDD-plus in many parts of the world.

November, 2012

REDD Research and Development Center  
Forestry and Forest Products Research Institute

# Contents

REDD-plus Flow Chart	6
Introduction	7
<b>Chapter 1 About REDD-plus</b>	<b>8</b>
Recipe - I01 History of REDD-plus and current status	10
About REDD-plus / Scientific background / Historical background /	
Current status of REDD-plus under the UNFCCC / Other measures / Future challenges	
Recipe - I02 Key REDD-plus concepts	14
Forest, deforestation, forest degradation, and the "plus" in REDD-plus / Target scale /	
Reference emission level and reference level /	
Measurement, reporting and verification of forest carbon stocks / Credits /	
Phased approach / Safeguards	
<b>Chapter 2 Designing a forest monitoring system</b>	<b>20</b>
Recipe - I03 Measurement, reporting and verification (MRV) of forest monitoring	22
MRV / Measurement / Reporting / Verification /	
Designing a forest monitoring system / Matters to be considered in the system design	
Recipe - I04 Designing the forest monitoring system	26
Compliance with international agreements and rules / Consideration of national circumstances /	
Capacity of implementation countries and possibility of sustained operation /	
Construction of a gradual and flexible structure	
Planning	29
<b>Chapter 3 Basic knowledge needed for REDD-plus implementation</b>	<b>30</b>
Recipe - P01 Definitions of forest, deforestation, forest degradation, and the "plus" in REDD-plus	32
Forest / Deforestation / Forest degradation / The "plus" in REDD-plus	
Recipe - P02 Phased approach	34
Phase 1: Readiness / Support for readiness phase / Phase 2: Implementation /	
Phase 3: Full implementation	
Recipe - P03 Safeguards	38
Safeguards in REDD-plus / The safeguards in the UNFCCC / Social and environmental safeguards /	
Effects and significance of safeguards / Institutional challenge for ensuring safeguards	
<b>Chapter 4 Measurement, reporting and verification of forest carbon</b>	<b>42</b>
Recipe - P04 Measurement of forest carbon	44

What to measure? / How to measure?	
Recipe - P05 Reporting of forest carbon .....	46
What is reporting? / National communications / National greenhouse gas inventory /	
Biennial update reports / International consultation and analysis / Reporting requirements	
Recipe - P06 Verification of forest carbon .....	50
What is verification? / Verification requirements and procedures /	
Basic approach to verification in the forest sector / Verification of REDD-plus activities	
<b>Chapter 5 Monitoring by the stock change method</b> .....	<b>54</b>
Recipe - P07 Stock change method .....	56
What is the stock change method? / Area estimation / Estimation of forest area change /	
Estimation of the carbon stocks per unit area / Estimation of carbon stock change	
Recipe - P08 Area estimation using remote sensing .....	60
Types of remotely sensed data and software / Data pre-processing /	
Definition of classes / Ground truth / Classification methods /	
Verifying the accuracy of classification results / Estimation of forest area change	
Recipe - P09 Estimation of carbon stocks per unit area .....	64
Attainable resources / Direct measurement of carbon stocks (permanent sample plot method) /	
Indirect measurement of carbon stocks (stand estimation model method)	
Recipe - P10 Permanent sample plot method .....	66
Required number of permanent sample plots and their locations /	
Design and measurement of permanent sample plots / Analysis of permanent sample plot data	
Recipe - P11 Using a stand carbon stock estimation model .....	68
Establishment and verification of the model / Overstory height method /	
Crown diameter method / Community age method /	
Backscattering coefficient method	
Recipe - P12 Calculation of carbon emissions and removals .....	70
Calculation of carbon stocks and carbon stock changes /	
Uncertainties of the calculated amounts	
Recipe - P13 Reference emission level and reference level .....	72
Establishment of reference emission level and reference level /	
Discussions under UNFCCC / Organizational challenges	
Technical .....	75
<b>Chapter 6 Preparation for REDD-plus implementation</b> .....	<b>76</b>
Recipe - T01 National forest inventory .....	78
What is national forest inventory? / National forest inventory sampling designs /	
Conducting the inventory / National forest inventories in tropical countries	
Recipe - T02 What greenhouse gases are measured? .....	80
Which greenhouse gases should be the target of REDD-plus activities / Five forest carbon pools	

Recipe - T03	Attainable resources .....	82
	Remote sensing resources / Field survey resources / Continuity of resources	
Recipe - T04	Voluntary carbon credit certification system .....	84
	The present status of the VER certification system / VCS / Future considerations	

## Chapter 7 Estimation of forest area using remote sensing 86

Recipe - T05	Remote sensing and sensor types, and image data selection .....	88
	Platforms / Sensors / Spatial resolution, wavelength resolution, and time resolution / Present, past, and future / Selection of image data / Software	
Recipe - T06	Clouds and seasonality differences in images .....	96
	Cloud removal / Seasonality adjustment	
Recipe - T07	Definition of a land cover class .....	98
	Mutually exclusive and collectively exhaustive classes / Desired and possible classification systems / Integration of classes after classification	
Recipe - T08	Ground truth .....	100
	Ground truth / Location of ground truth and its accuracy / Sampling method / Number of samples	
Recipe - T09	Classification methods .....	102
	Classification in remote sensing / Classification by pixel and object-based classification	
Recipe - T10	Accuracy evaluation .....	104
	The error matrix and accuracy indicators / Uncertainty of the error matrix and ground truth	
Recipe - T11	Estimation of forest area change .....	110
	Comparison after the classification of images acquired at two different times / Detection of land cover changes by multi-temporal classification / Some notes on the change detection	

## Chapter 8 Permanent sample plot method 112

Recipe - T12	Selecting the number and arrangement of permanent sample plots .....	114
	Required accuracy / How to calculate the required number of permanent sample plots / Suitable stratification	
Recipe - T13	Measurement of permanent sample plots .....	116
	Plot size / Plot shape / Preparation for a tree census / Raising measurement accuracy	
Recipe - T14	Analysis of permanent sample plot data .....	120
	About allometric equations / Selection of an allometric equation suitable for the target region	

## Chapter 9 Stand carbon stock estimation models 124

Recipe - T15	Model design .....	126
	Double sampling / Indirect estimation of carbon stocks by correlation models / Evaluation of model accuracy and costs / Notes about applying the models to a target forest	
Recipe - T16	Overstory height method .....	130

Correlation between overstory height and biomass / Measurement of overstory height by remote sensing / Factors affecting estimation accuracy	
<b>Recipe - T17 Crown diameter method</b> .....	<b>132</b>
Measuring tree crown diameters for estimation of carbon stocks / Determining the relationship between tree crown diameter and biomass / Notes on the use of the crown diameter method	
<b>Recipe - T18 Community age method</b> .....	<b>134</b>
About the community age method / Creation of the relational equation by field survey / Advantages and disadvantages of the community age method	
<b>Recipe - T19 Backscattering coefficient method</b> .....	<b>136</b>
About the backscattering coefficient method / Creation of the estimation model by field survey / An example of biomass estimation / Advantages and disadvantages of the backscattering coefficient method	
 Reference Guide .....	 <b>139</b>
 Index .....	 <b>152</b>
 Authors .....	 <b>156</b>

# REDD-plus Flow Chart

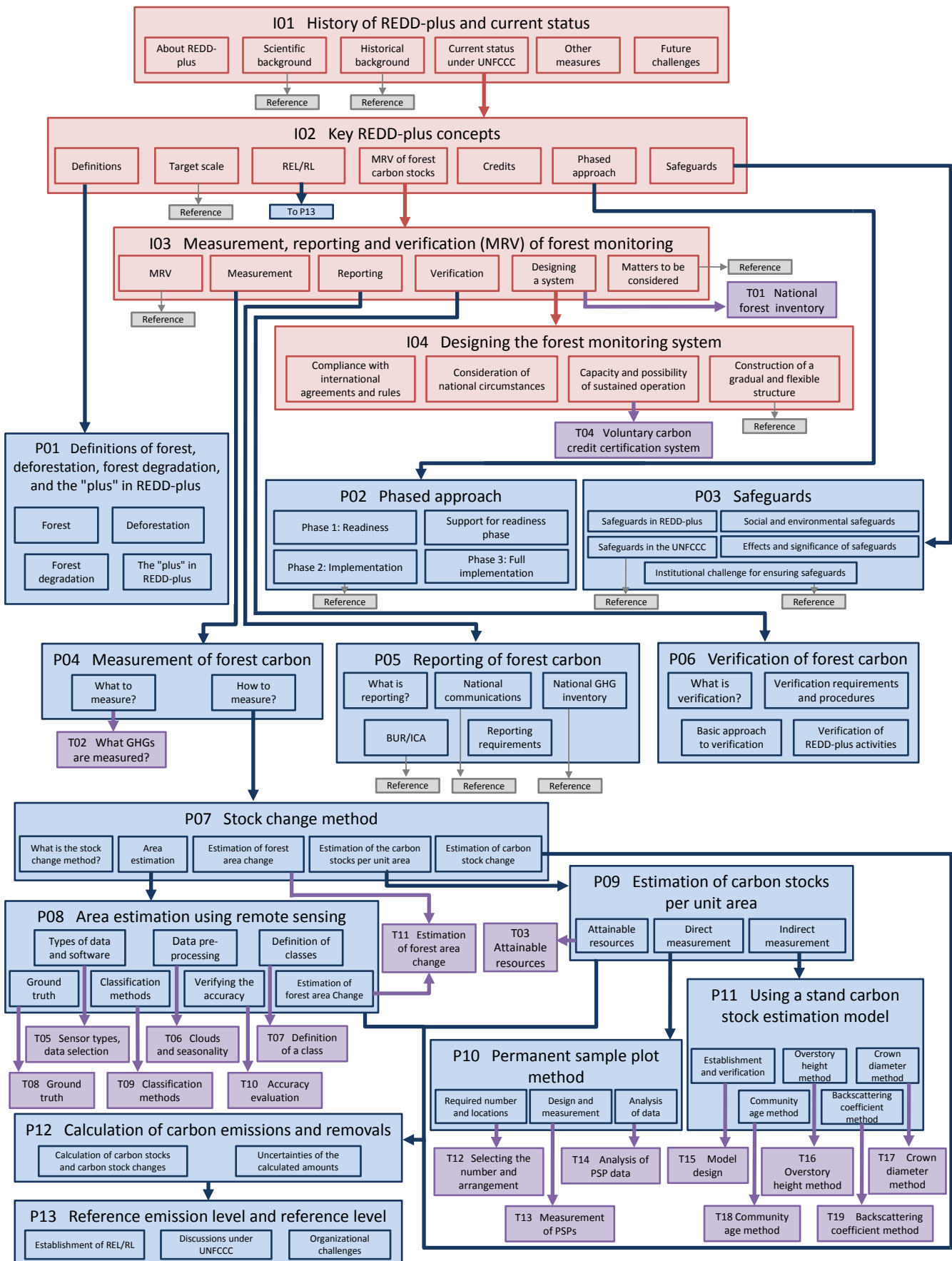



# Introduction



# 1

## Chapter 1 About REDD-plus



An idea of REDD – reducing emissions from deforestation and forest degradation in developing countries – was proposed by Papua New Guinea and Costa Rica at the 11<sup>th</sup> Conference of the Parties (COP 11) to the United Nations Framework Convention on Climate Change (UNFCCC), as a climate change mitigation framework. At COP 13, REDD was expanded to encompass measures for forest conservation, sustainable management of forests, and enhancement of forest carbon stocks. This expanded version is known as REDD-plus.

In this chapter, REDD-plus and REDD-plus activities and scope are introduced and explained, including the history of REDD-plus and important concepts that arose in the course of REDD-plus negotiations and the implementation of REDD-plus under the UNFCCC and related efforts undertaken by other organizations.

I01 History of REDD-plus and current status

I02 Key REDD-plus concepts

## History of REDD-plus and current status

The main cause of global climate change is increased atmospheric levels of carbon dioxide (CO<sub>2</sub>) in association with high CO<sub>2</sub> emissions, and deforestation and forest degradation in developing countries, which account for approximately 20 percent of global CO<sub>2</sub> emissions, are the second largest source of emissions after fossil fuel combustion. Accordingly, it is vital to reduce emissions from deforestation and forest degradation. REDD-plus is an international framework for achieving these reductions. In this recipe, the scientific and historical background of REDD-plus and its current status are explained.

### INFO

1) Denman KL, Brasseur G, Chidthaisong A, Ciais P, Cox PM, Dickinson RE, Hauglustaine D, Heinze C, Holland E, Jacob D, Lohmann U, Ramachandran S, da Silva Dias PL, Wofsy SC, Zhang X (2007) Couplings Between Changes in the Climate System and Biogeochemistry. In: Climate Change 2007: The Physical Science Basis, Contribution of Working Group I to the Fourth Assessment Report of the IPCC. Cambridge University Press, 499-587

### INFO

2) Nabuurs GJ, Masera O, Andrasko K, Benitez-Ponce P, Boer R, Dutschke M, Elsiddig E, Ford-Robertson J, Frumhoff P, Karjalainen T, Krankina O, Kurz WA, Matsumoto M, Oyhantcabal W, Ravindranath NH, Sanz Sanchez MJ, Zhang X (2007) Forestry. In: Climate Change 2007: Mitigation of Climate Change, Contribution of Working Group III to the Fourth Assessment Report of the IPCC. Cambridge University Press, 541-584

### INFO

3) FAO (2006) Extent of forest resources. In: Global Forest Resources Assessment 2005. FAO Forestry Paper 147: 11-36

## About REDD-plus

REDD-plus – reducing emissions from deforestation and forest degradation, and the role of conservation, sustainable management of forests, and enhancement of forest carbon stocks – is a climate change mitigation framework. Initially, REDD-plus was just one item on the agenda concerning future climate change mitigation under the United Nations Framework Convention on Climate Change (UNFCCC), but as UNFCCC discussions have proceeded, REDD-plus has been modified to include bilateral and multilateral activities by Parties to the Convention and private activities. Currently, forest conservation activities to mitigate climate change in developing countries come under REDD-plus, and REDD-plus is the acknowledged framework for providing economic incentives (credits, funds, etc.) for reducing CO<sub>2</sub> emissions from deforestation and forest degradation, or increasing CO<sub>2</sub> removals by enhancement of forest carbon stocks.

## Scientific background

The Intergovernmental Panel on Climate Change (IPCC) Third Assessment Report, issued in 2001, noted that CO<sub>2</sub> emissions from deforestation and forest degradation in developing countries have a large impact on the global carbon cycle. The IPCC Fourth Assessment Report (AR4), issued in 2007, reported that 80 percent of CO<sub>2</sub> was emitted by fossil fuel combustion and cement production, and that the remaining 20 percent was emitted as a result of land-use changes such as deforestation <sup>1)</sup>. The IPCC Fourth Assessment Report also reported that about 65% of the total mitigation potential in the forestry sector is located in the tropics and about 50% of the total could be achieved by reducing emissions from deforestation <sup>2)</sup>. Data from the Food and Agriculture Organization (FAO) show that deforestation rates in Brazil, Indonesia, and tropical Africa is quite high <sup>3)</sup>, and the Stern Review has emphasized that curbing deforestation is a highly

cost-effective way of reducing greenhouse gas (GHG) emissions <sup>4), 5)</sup>.

The IPCC Fourth Assessment Report devoted many pages to the significance of REDD-plus activities, which not only mitigate climate change but also contribute to the livelihoods of indigenous people and other members of local communities by protecting biodiversity and conserving the ecological services provided by healthy forest ecosystems, such as forest products, water resources, and environmental quality. Even though the significance and necessity of REDD-plus has been recognized since an early stage of the negotiations, the UNFCCC does not include a framework for reducing deforestation and forest degradation in developing countries. The REDD-plus framework is being developed in the context of this scientific background.

## Historical background (see I02)

Discussions on REDD-plus began at the 11<sup>th</sup> Conference of the Parties (COP 11), which was held in Montreal in 2005, when Papua New Guinea and Costa Rica jointly presented a proposal called "Reducing emissions from deforestation in developing countries: approaches to stimulate action." This proposal, which was adopted as an agenda item by the Subsidiary Body for Scientific and Technological Advice (SBSTA), is referred to as REDD – reducing emissions from deforestation in developing countries.

Initially, the SBSTA intended to discuss the proposal for two years and then to report the results of those discussions at COP 13, but in the course of the discussions, many developing countries requested that REDD should include mechanisms for the conservation and sustainable management of forests and enhancement of forest carbon stocks (thus, the "plus" in REDD-plus) in addition to mechanisms for reducing emissions from deforestation and forest degradation. Therefore, at COP 13, held in Bali in 2007, the proposal was broadened to include these activities and adopted as an agenda item in discussions on the development of a post-2013 framework. This broadened framework is referred to as REDD-plus.

After a further two-year review, the necessity of early development of the REDD-plus framework including a financing mechanism was noted in the Copenhagen Accord, adopted by COP 15 in 2009 <sup>6)</sup>. It was also agreed to use the latest IPCC guidelines to establish a forest monitoring system at national or sub-national levels that uses a combination of remote sensing with a ground-based inventory, and to take into account each respective country's historical and present circumstances to establish reference level to serve as standards against which to evaluate actions. This agreement is the basis of the current REDD-plus technical methodology <sup>7)</sup>.

At COP 16, held in Cancun in 2010, the basic framework for REDD-plus,

### INFO

4) Stern N (2007) Identifying the costs of mitigation. In: Stern review on the economics of climate change. Cambridge University Press, 211-238

### INFO

5) This observation is based on the evaluation of the opportunity cost of land-use changes; the costs of maintaining domestic systems when implementing REDD-plus and of monitoring system development are not taken into consideration.

### INFO

6) UNFCCC (2009) Decision 2/CP.15, FCCC/CP/2009/11/Add.1, 4-7, UNFCCC

### INFO

7) UNFCCC (2009) Decision 4/CP.15, FCCC/CP/2009/11/Add.1, 11-12, UNFCCC

## INFO

8) UNFCCC (2010) III-C, Decision 1/CP.16, FCCC/CP/2010/7/Add.1, 12-14, UNFCCC

which includes five targeted activities, a phased approach, and consideration of safeguards, was proposed <sup>8)</sup> (Table I01-1). Thus, under the UNFCCC, this Cancun Agreement is the basis of REDD-plus.

Table I01-1 Excerpts from the Cancun Agreements related to REDD-plus

1	Affirming Parties should collectively aim to slow, halt and reverse forest cover and carbon loss
2	Encourages developing country Parties to undertake the following activities: (a) Reducing emissions from deforestation; (b) Reducing emissions from forest degradation; (c) Conservation of forest carbon stocks; (d) Sustainable management of forests; and (e) Enhancement of forest carbon stocks;
3	Indicated in the Guidance: be consistent with the objective of environmental integrity and take into account the multiple functions of forests and other ecosystems; respect sovereignty; be results-based; promote sustainable management of forests; etc.
4	Requests developing country Parties to develop the following elements: (a) A national strategy or action plan; (b) A national forest reference emission level and/or forest reference level; (c) A national forest monitoring system; and (d) A system for providing information on the safeguards;
5	Decides that the activities should be implemented in three phases: 1st. Readiness; 2nd. Implementation; and 3rd. Results-based actions;
6	Safeguards to be promoted and supported: transparent and effective national forest governance structures; respect for the knowledge and rights of indigenous peoples and members of local communities; actions consistent with the conservation of natural forests and biological diversity; etc.

### Current status of REDD-plus under the UNFCCC (see I02)

In the Durban Agreement, concluded at COP 17 in 2011, it was agreed that all countries would participate in the development of a new framework that would replace the Kyoto Protocol. This framework should be completed by 2015 and put into effect in 2020. So that REDD-plus can be positioned in the new framework, methodologies and rules for implementing REDD-plus are to be developed by 2015 with the aim of starting its implementation in 2020.

At COP 17, agreement was reached regarding guidance on systems for providing information on how safeguards are addressed and respected and modalities relating to forest reference emission levels and forest reference levels in REDD-plus <sup>9)</sup>. Still under review are identification of drivers of deforestation and forest degradation, development of evaluation methods of measures and estimation methods for measuring emissions and removals by forests, modalities for a credible system for measurement, reporting, and verification, and requirements for a national forest monitoring system. Discussion of mechanisms for financing measures to reduce deforestation and forest degradation in developing countries and to obtain support from

## INFO

9) UNFCCC 2011) Decision 12/CP.17, FCCC/CP/2011/9/Add.2, 16-18, UNFCCC

developed countries are also left for the future.

## Other measures

Although REDD-plus is still being discussed and developed under the UNFCCC, it will take time to obtain consensus among participating countries. In the meantime, deforestation and forest degradation rates are undeniably increasing. To reverse this trend, early implementation of REDD-plus is required. With this in mind, voluntary efforts outside of the UNFCCC are being made.

The "REDD-plus Partnership" was established in May 2010 as an interim platform for promoting REDD-plus activities, and as of 24 August 2012, 75 Partner countries joined it. In addition, various organizations have developed bilateral or multilateral projects. Among the best known are the World Bank's Forest Carbon Partnership Facility (FCPF); UN-REDD, organized by the FAO, the U.N. Development Programme (UNDP), and the U.N. Environment Programme (UNEP); and Australia's International Forest Carbon Initiative. The Japanese government has proposed the a Bilateral Credit Offset Mechanism (BOCM) and is considering introducing REDD-plus activities.

The Verified Carbon Standard (VCS) is a third-party accreditation standard certifying voluntary emission reductions (VERs) within the voluntary carbon market, and it is now widely used to evaluate voluntary REDD-plus activities at the project level (see T04).

## Future challenges

National forest monitoring and measurement, reporting, and verification (MRV) systems (see I03) should be developed on a sound scientific basis, with a view toward their feasibility for developing countries, and they should appropriately reflect on-going efforts and experience.

Reference levels should be established by considering practical examples, not just theory. In developing reference levels, it is very important to take each country's circumstances and historical emissions trend into account. Safeguards (see P03) are also important, but their specific attributes still require clarification. Thus, appropriate evaluation and reporting methods still need to be developed.

In REDD-plus participating countries, numerous voluntary projects led by private sector organizations are being carried out in tandem with REDD-plus-activities at national or sub-national levels under the UNFCCC. Development of a consistent way to fit these projects into the REDD-plus framework is a challenge for the future.

## Key REDD-plus concepts

The preceding Recipe is

Recipe I01 History of REDD-plus and current status

Discussions of REDD-plus by Parties of the United Nations Framework Convention on Climate Change (UNFCCC) carried out over the years from various perspectives have established certain important concepts necessary to understand the REDD-plus framework. In this recipe, these important concepts are explained.

### Forest, deforestation, forest degradation, and the "plus" in REDD-plus (see P01)

REDD was originally proposed at the 11<sup>th</sup> Conference the Parties (COP 11), and at COP 13, REDD was expanded to encompass forest conservation, sustainable management of forests, and enhancement of forest carbon stocks, and the expanded version was called REDD-plus (see I01). Currently, REDD and "plus" are invariably considered together, but in fact, REDD refers to activities to curb human-related pressures such as land-use change and logging, whereas "plus" refers to activities designed to conserve or enhance forest carbon stocks.

A "forest" is not quantitatively defined in the Intergovernmental Panel on Climate Change (IPCC) guidelines. Instead, it was agreed that the definition established by each country should be used for that entire country in time

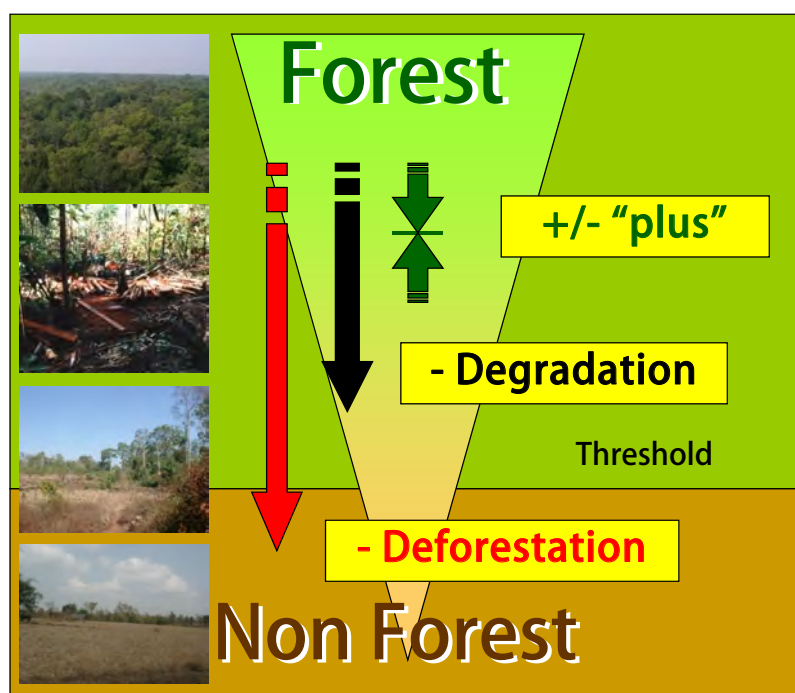

Figure I02-1 Definitions of forest, deforestation, forest degradation, and the "plus" in REDD-plus



series measurements. However, the Kyoto Protocol and the Global Forest Resources Assessments (FRA) by the Food and Agriculture Organization (FAO) have adopted definitions based on quantitative criteria for minimum area, minimum potential tree height, and minimum crown cover. In the Kyoto Protocol, "deforestation" is defined as the direct human-caused conversion of an area from "forest" to "non-forest" (Figure 102-1). A similar definition of "deforestation" is used in REDD-plus, but how to identify anthropogenic conversion and the definitions of "forest degradation" and the "plus" in REDD-plus are still under discussion.

## Target scale

REDD-plus can be implemented at one of three scales or levels: national, sub-national, or project level. The implementation of REDD-plus activities in a certain area can cause leakage to other areas. Here, the concept of leakage is the same as "displacement" used by the Clean Development Mechanism (CDM). Leakage occurs when the curbing of deforestation and forest degradation in areas of REDD-plus implementation leads to increases of deforestation or forest degradation in other areas. The UNFCCC considers that leakage to different areas of a country can be avoided by implementing REDD-plus at the national level and that leakage to other countries should be addressed by increasing the number of countries participating in REDD-plus. However, at this time, each country that is a Party to the UNFCCC decides whether to participate in REDD-plus, and leakage to other countries from REDD-plus participating countries is a concern. For example, if country A cracks down on illegal logging, then the illegal loggers may move to country B and harvest trees there illegally. As a result, although REDD-plus activities successfully reduce greenhouse gas emissions due to deforestation and forest degradation in country A, emissions might increase in country B, where the illegal logging is now occurring.

Although implementation of REDD-plus at the national level is best, for some countries immediate national implementation may not be feasible, depending on the country's capacities and size. For this reason, implementation at the sub-national level has been proposed. "Sub-national" has yet to be defined, however, and the size of the target area might vary according to a country's size and the administrative subdivisions that it uses. For example, if a certain country consists of three states, A, B, and C, and REDD-plus is implemented in two states (A and B), and states A and B each reduce emissions by one and two units, but emissions increase in state C by four units, then the country is credited although an emission of one unit totally increases in the country. Thus, the sub-national level can be effective

**INFO**

1) Denman KL, Brasseur G et al. (2007) Couplings Between Changes in the Climate System and Biogeochemistry, Climate Change 2007 - The Physical Science Basis (IPCC), 499-587, Cambridge University Press.

for initial implementation of REDD-plus, but it is regarded as transitional to full implementation at the national level <sup>1)</sup>.

Although the REDD-plus framework has not yet been finally established under the UNFCCC, REDD-plus activities are being carried out at the project by private organizations such as NGOs on a voluntary basis. Project-level implementations of REDD-plus are effective at reducing emissions, but emissions data may not be of comparable accuracy among projects, even among those carried out in the same country, because different methods may be used to calculate forest carbon stocks and carbon stock changes. When REDD-plus is later fully implemented at the national level in countries where project level activities are being carried out, reconciliation of estimates of forest carbon stocks obtained at project level by different methods with different degrees of accuracy with the national-level estimates will be a big challenge.

**Reference emission level and reference level** (see P13)

The basic concept of REDD-plus is to provide economic incentives such as funding or credits to developing countries for REDD activities (reducing emissions from deforestation and forest degradation) and "plus" activities (reducing CO<sub>2</sub> emissions and CO<sub>2</sub> levels in the atmosphere by carbon sequestration). To quantify reductions in CO<sub>2</sub> emissions due to REDD-plus activities, compared with the case where no REDD-plus activities are undertaken, a reference emission level and a reference level have been established. In expert meetings held at the request of the SBSTA, the distinction between "reference emission level" and "reference level" has been

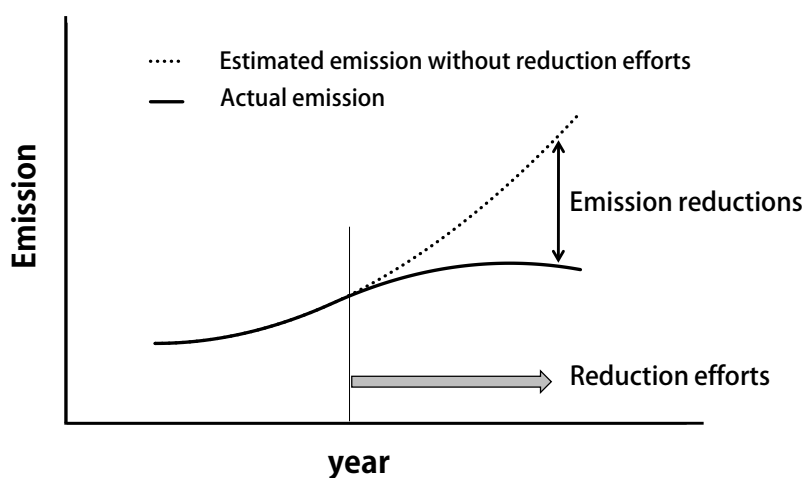

Figure I02-2 The concept of emission reductions

made in two ways: in the first, "reference emission level" is defined as net emission, and "reference level" as net absorption, at the national level, and in the second, the "reference emission level" is defined as the level for use in evaluating the emissions reductions from REDD activities, and "reference level" is defined as that to be used to evaluate the emissions reductions from "plus" activities. In some cases, both definitions might be used even in the same country.

COP 15 concluded that when developing countries establish a reference emission level or reference level, they should establish it using historical data according to their national circumstances while at the same time ensuring transparency. COP 16 decided that a forest reference emission level and a forest reference level at the national level, or at the sub-national level as a transitional measure, should be established for implementation of REDD-plus activities in developing countries. However, the definitions of these reference levels and details of how to establish them have yet to be settled.

### **Measurement, reporting and verification of forest carbon stocks** (see I03)

In discussions on the framework after the first commitment period of the Kyoto Protocol in 2012 under the UNFCCC, the importance of the measurement, reporting, and verification (MRV) system has been emphasized. When REDD-plus is implemented, MRV of forest carbon stocks is essential to ensure transparency. In particular, MRV must be highly accurate before economic incentives such as credits are issued.

A forest monitoring system is indispensable for accurate measurement of forest carbon stocks and their changes at the national level. The guidance for the methodology determined by COP 15 under the UNFCCC requests that developing countries build a robust and highly transparent national forest monitoring system. To estimate the balance of greenhouse gases, forest carbon stocks, and forest cover changes, a monitoring system that combines remote sensing with ground-based inventories is recommended.

Credits for REDD-plus activities will be issued based on the results of this measurement. To ensure a reliable and transparent credit system for greenhouse gas reductions, a system for reporting and verifying the measurement results is indispensable.

### **Credits**

REDD-plus will include a mechanism to provide economic incentives for the efforts of developing countries to reduce CO<sub>2</sub> by reducing deforestation

and forest degradation and conserving existing forests. One type of economic incentive is carbon credits. Under the UNFCCC, both a fund-based approach and a market-based approach have been proposed, and a hybrid approach is under consideration for the implementation of REDD-plus. In the market-based approach, tradable credits for greenhouse gas emissions reductions or removals achieved by REDD-plus will be issued.

Although the REDD-plus framework is still being developed under the UNFCCC, REDD-plus activities at project level have already been initiated by private organizations such as NGOs in many parts of the world, along with the trading of credits in voluntary carbon markets (see T04). When REDD-plus is implemented at the national or sub-national level under the UNFCCC, the credits issued for those REDD-plus activities may not be equivalent to those being traded in the voluntary carbon market, because of possible differences in the accuracy level of MRV, and reconciling the differences will be a challenge. In addition, offset credits are traded in the voluntary market, whereas credits for achieving national targets, such as Kyoto credits, are compliance market credits. Which type of credit will be used for REDD-plus activities under the UNFCCC is a major concern of stakeholders.

### **Phased approach** (see P02)

---

The basic concept of REDD-plus is to provide performance-based economic incentives, for which MRV of forest carbon stocks is needed. Many developing countries, however, do not have adequate historical data, and they also differ in their implementation capacities. Therefore, a phased approach that allows REDD-plus to be implemented in steps according to each country's circumstances has been proposed and discussed during the negotiation sessions. This phased approach was reviewed and agreed by COP 16.

According to this agreement, REDD-plus can be implemented in three phases:

- Phase 1 is Readiness: National capacity building and strategy formulation.
- Phase 2 is Implementation: Implement policies and measures of the national strategy.
- Phase 3 is Full implementation: Full implementation of activities for which economic incentives based on the achievement of emission reductions are provided.

During the first phase, highly accurate MRV of forest carbon stocks by

developing countries is not expected; therefore, phase 1 MRV cannot be regarded as equivalent to MRV during phase 3. Thus, during phase 1, it is recommended that Official Development Assistance (ODA) and other funds be provided.

## **Safeguards** (see P03)

---

The basic concept of REDD-plus as a climate mitigation framework is the provision of economic incentives to reward efforts at reducing emissions from deforestation and forest degradation, and enhancing forest carbon stocks. To obtain the offered economic incentives, however, indigenous peoples or local communities might be restricted or banned from using forests or natural forest might be converted to a fast growing plantation. Such activities would infringe on the rights of indigenous peoples and local communities, and cause a loss of biodiversity. Therefore, the discussions under the UNFCCC have recommended the development of safeguards designed to reduce the risk of negative impacts on the social and natural environment, and to increase the positive impact on them.

The development of safeguards has received much attention of various actors, such as the Conference of the Parties to the Convention on Biological Diversity, international organization, donor countries, NGOs, etc. At COP 17, "guidance on systems for providing information on how safeguards are addressed and respected" was adopted. However, specific methods and regulations for implementing safeguards have not yet been clarified under the UNFCCC, because national circumstances vary among countries. For promoting and supporting safeguards, further discussion to official rules under the UNFCCC is expected.

# 2

## Chapter 2 Designing a forest monitoring system



Developing countries are requested to develop a forest monitoring system for the estimation of the greenhouse gas emissions from forests and changes in forest carbon stocks and forest area. Such a system is essential not only for implementation of REDD-plus but also for sustainable management of forests. This estimate is then used to estimate the reduction of greenhouse gas emissions attributable to REDD-plus activities, according to which credits will be issued. Therefore, the monitoring must be conducted in manner that is reliable, transparent, and as accurate as possible, as well as feasible for developing countries and acceptable by the global community. Moreover, a flexible system is necessary, because the circumstances of each country are different.

In this chapter, the design of a forest monitoring system that includes measurement, reporting, and verification (MRV) according to internationally agreed requirements is considered.

I03 Measurement, reporting and verification (MRV) of forest monitoring

I04 Designing the forest monitoring system

## Measurement, reporting and verification (MRV) of forest monitoring

The preceding Recipe is

Recipe I02 Key REDD-plus concepts

Measurement, reporting, and verification (MRV) is a concept of mechanism and/or requirements to enable objective evaluation of the implementation status of REDD-plus policies and emissions and removals for the credit mechanism. How to implement MRV at national and sub-national levels for REDD-plus is still under discussion, but some voluntary credit verification systems used by the private sector (e.g., Verified Carbon Standard (VCS); see T04) have already proposed the framework for MRV implementation at the project level, taking into account institutional designs of similar frameworks such as the Clean Development Mechanism (CDM). In this chapter, what is meant by "measurement", "reporting", and "verification" is outlined and the MRV requirements of forest monitoring for REDD-plus are explained.

### INFO

1) MRV is the concept to realize domestic and international actions for the mitigation of climate change and to guarantee the quality of the actions. The measurement and the report in the National Communications (NCs) in the Copenhagen Accord and their verification by the International Assessment and Review (IAR) are an example of the agreed MRV frameworks.

### INFO

2) Intergovernmental Panel on Climate Change (IPCC) National Greenhouse Gas Inventories Programme (2003) Good practice guidance for land use, land-use change, and forestry. Technical Support Unit IPCC National Greenhouse Gas Inventories Programme, IGES, Hayama, Japan

## MRV

The concept of MRV was introduced in the Bali Action Plan agreed at the 13<sup>th</sup> Conference of the Parties (COP13) in 2007. According to this plan, greenhouse gas (GHG) mitigation actions and commitments must be measurable, reportable, and verifiable. However, international discussions on the specific purpose and target of MRV and on who is responsible for implementing it are still in progress <sup>1)</sup>. As of 2012, MRV modalities of forest monitoring for REDD-plus were also under consideration by the Subsidiary Body for Scientific and Technological Advise (SBSTA). Data on greenhouse gas emissions and removals obtained by using appropriately designed MRV will be an important basis for evaluating the effectiveness of REDD-plus activities.

## Measurement (see P04)

REDD-plus activities are evaluated according to the emissions reductions and removals that result. Thus, these amounts must be measured. In forest monitoring, "measurement" means the continuous measurement and collection of data on anthropogenic forest-related greenhouse gas emissions by sources and removals by sinks, forest carbon stocks and forest area changes <sup>2)</sup>.

More specifically, REDD-plus participating countries must periodically measure forest cover changes and emissions and removals per unit of land area where the activities are carried out, in accordance with guidance provided by the United Nations Framework Convention on Climate Change (UNFCCC), and calculate total forest greenhouse gas emissions and removals



from the acquired data. The measurement system must be transparent, consistent, and accurate, and uncertainty should be minimized, but it must also be feasible for the participating country. In the future, "measurement" for safeguards and other functions of forest will presumably be required.

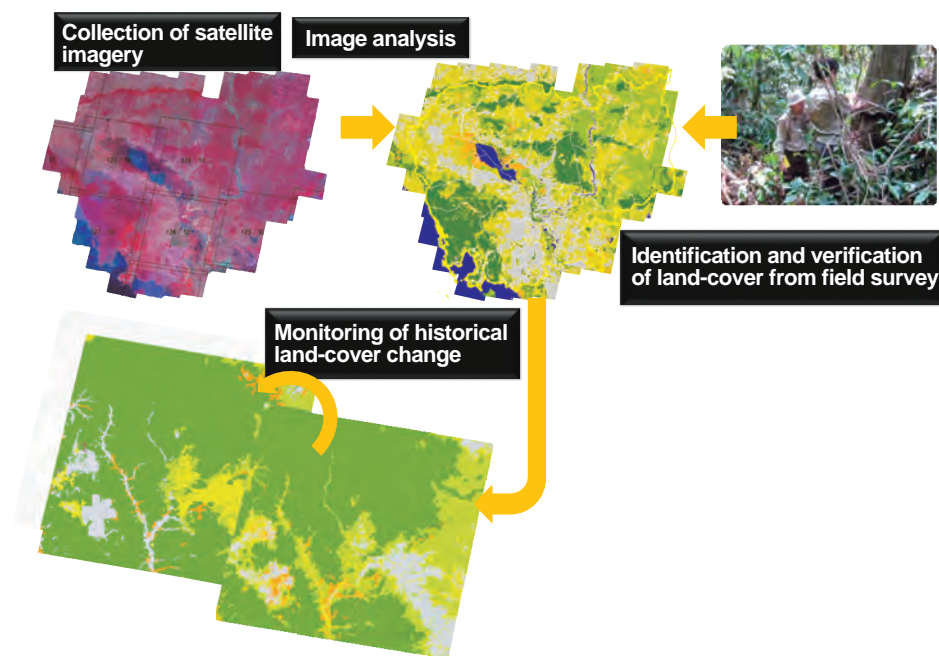

Figure I03-1 Measurement of forest cover changes and emissions and removals per unit of land area

## Reporting (see P05)

Reporting means providing information on the estimated greenhouse gas emissions and removals, on the methods and procedures used to determine them, and on the status and future outlook for measures of emission reductions and removals by sinks in accordance with prescribed forms and procedures. In the precedent frameworks of emission reductions, such as the national reports under UNFCCC and the CDM or other voluntary verification schemes at the project level, the forms and procedures vary with the subject being reported and the purpose of the report. In any case, reports should include all information needed for verification so that additional information does not need to be submitted later. The UNFCCC has obliged the Parties to report a country's national greenhouse gas inventory, and the report to conform to the following five principles: transparency, consistency, comparability, completeness, and accuracy. All reports of REDD-

plus activities should presumably require conforming to these five principles, too. Transparency is particularly important for developing countries, because adequate historical data is often lacking and data collection is difficult.

## **Verification** (see P06)

---

Verification means reviewing the contents of reports and confirming that the specified requirements have been met. Although verification requirements and procedures differ depending on the purpose and target of the measurement, verification is essential to ensure that a system and framework of emission reductions and removals by sinks is fair and reliable.

In particular, under the mechanism for providing economic incentives or trading credits (e.g., CDM or the voluntary carbon credit system), the verification is a mandatory process of ex-post evaluation of the emission reductions achieved by the project by which the reliability of the credit is ensured. By the process, it is required to ensure that the project has been duly implemented according to the project plan. To guarantee the fairness of the verification, it must be executed by a third-party organization. The same will presumably be true when REDD-plus is implemented under the UNFCCC.

## **Designing a forest monitoring system** (see I04)

---

So that the MRV-based credit estimation will have the confidence of the international community, the design of the forest monitoring system must be based on international agreements and rules. The UNFCCC requests that forest monitoring at the national level be conducted according to IPCC guidelines.

Nevertheless, because not only forests but also the political situation, economy, and culture differ among REDD-plus participating countries, national circumstances also need to be considered in the design of the forest monitoring system. In particular, national sovereignty and policies regarding development goals, sustainable development, and necessary safeguards (see P03) need to be taken into account.

The forest monitoring system should be developed with consideration of the capacity of the REDD-implementing country, but if a country's monitoring capacity is not sufficient, capacity-building actions should be undertaken. Such a system cannot be completed in a short period; it must be developed using a progressive and flexible approach to improve a country's readiness for implementation (phased approach; see P02).

## Matters to be considered in the system design

People involved in REDD-plus activities should keep the two principles, fairness and transparency, in mind. Especially when REDD-plus proponents select and implement REDD-plus interventions (e.g., when they change the current land-use pattern), the measurement, reporting, and verification of the data resulting from these activities need to be fair and transparent. Adherence to these principles will show the stakeholders that their legitimate interests are consistent with REDD-plus and build their confidence in the program and those who are involved with its implementation.

Moreover, even if a forest monitoring and MRV system is already in place, the ultimate goal of REDD-plus (i.e. mitigating climate change) is unlikely to be achieved if the objectives of REDD-plus activities are not shared among the stakeholders. REDD-plus cannot achieve climate change mitigation cheaply <sup>3)</sup>, and the potential climate benefits of REDD-plus might not as big as is sometimes reported <sup>4)</sup>. Therefore, it is essential for all stakeholders to work together to achieve better implementation of MRV and more effective REDD-plus interventions.

### INFO

3) IPCC (2007) Climate Change 2007: Mitigation of Climate Change. Contribution of Working Group III to the Fourth Assessment Report of the Intergovernmental Panel on Climate Change. [Metz, B, Davidson OR, Bosch PR, Dave R, Meyer LA (eds)], Cambridge University Press, Cambridge, United Kingdom and New York, NY, USA . 851pp.

### INFO

4) Harris NL, Brown S, Hagen SC, Saatchi SS, Petrova S, Salas W, Hansen MC, Potapov PV, Lotsch A (2012) Baseline Map of Carbon Emissions from Deforestation in Tropical Regions. Science 336: 1573-1575

## Designing the forest monitoring system

The preceding Recipe is

Recipe 103 Measurement, reporting and verification (MRV) of forest monitoring

The forest carbon monitoring system for REDD-plus should comply with international agreements and rules to gain international recognition. On the other hand, because the system needs to effectively address the individual problems of each REDD-plus participating country, it is indispensable for each country's individual circumstances to be taken into account when the system is designed. Therefore, it is important to build the system progressively and flexibly in consideration of a country's capacity.

### INFO

1) UNFCCC (2009) Decision 4/CP.15, FCCC/CP/2009/11/Add.1, 11-12, UNFCCC

### Compliance with international agreements and rules

The United Nations Framework Convention on Climate Change (UNFCCC) requests that developing countries use the latest guidance documents and Intergovernmental Panel on Climate Change (IPCC) guidelines to estimate the greenhouse gas (GHG) emissions by sources and removals by sinks in the forest as well as changes in forest carbon storage and the forest area, and to develop a robust and transparent national forest monitoring system at the national (or sub-national) level <sup>1)</sup> (see I01). In addition, the system should (i) combine remote sensing with ground-based inventory, (ii) provide estimates that are transparent, consistent, and as accurate as possible, and (iii) be transparent itself, so that the result/outcome of the monitoring be compatible with the reporting and verification processes agreed by the Conference of the Parties (COP).

The latest IPCC guidelines at the present time (2012) is the 2006 IPCC Guidelines for National Greenhouse Gas Inventories, which consists of five volumes. And guidelines relevant to REDD-plus are discussed in Volume 1,



Figure I04-1 The 2006 IPCC Guidelines for National Greenhouse Gas Inventories

"General Guidance and Reporting (GGR)" and Volume 4 "Agriculture, Forestry, and Other Land Use (AFOLU)." The forest monitoring system must meet five standards, namely transparency, completeness, consistency, comparability, and accuracy (see I03) of the greenhouse gas inventory specified by the above-mentioned Guidelines.

REDD-plus will issue credits according to the greenhouse gas emission reduction and removal results. Therefore, countries implementing and participating in REDD-plus shall demonstrate forest carbon monitoring results accepted as reliable internationally and abide by all agreements and regulations to promote REDD-plus. For this purpose, the design of the forest carbon monitoring system should include provisions for measurement of forest carbon (see P04), reporting (see P05), and verification (see P06).

## Consideration of national circumstances

The circumstances of countries implementing REDD-plus differ with respect to forest type, politics, economy, and culture. Therefore, the design of the monitoring system should also take into account each country's individual circumstances. In particular, the country's sovereignty, consistency with other national policies such as development goals, sustainable development, and poverty reduction, and implementation of safeguards (see P03) should be respected <sup>2)</sup>.

REDD-plus participating countries are responsible for identifying the drivers of deforestation and forest degradation, the development of a national strategy or action plan for REDD-plus, establishment of the reference level or reference emission level (see P13), and development of a national forest monitoring system <sup>1),2)</sup>. If a participating country has already implemented a national forest inventory (NFI, see T01), the reference level or reference emission level might be established based on the inventory data. If it is not the case, necessary information of the past should be estimated by retrospective monitoring with available past data such as satellite images. Developed countries may provide assistance with the formulation of these, or, if they have already been determined, with their implementation or improvement.

Furthermore, the capacity of the REDD-plus participating countries and capacity-building potential should also be taken into consideration (see the following section).

Given limited resources, capacity, and time constraint, REDD-plus participating countries cannot always contend with all the problems at once. For this, it is indispensable for developed countries to understand the exact situation and priorities of the participating countries when they assist.

### INFO

2) UNFCCC (2010) Decision 1/CP.16, FCCC/CP/20010/7/Add.1, UNFCCC

**INFO**

3) Hardcastle PD, Baird D, Harden V (2008) Capability and cost assessment of the major forest nations to measure and monitor their forest carbon: Penicuik, UK, LTS International Ltd.

**INFO**

4) Herold M (2009) An assessment of national forest monitoring capabilities in tropical non-Annex I countries: Recommendations for capacity building, The Prince's Rainforests Project and The Government of Norway

**INFO**

5) Danielsen F et al. (2011) At the heart of REDD+: a role for local communities in monitoring forests? Conservation Letters 4(2): 158-167

**INFO**

6) UNFCCC (2009) Cost of implementing methodologies and monitoring systems relating to estimates of emissions from deforestation and forest degradation, the assessment of carbon stocks and greenhouse gas emissions from changes in forest cover, and the enhancement of forest carbon stocks, UNFCCC

**INFO**

7) UNFCCC (2011) Decision 12/CP.17, FCCC/CP/2011/9/Add.2, UNFCCC

**INFO**

8) Herold M, Skutsch MM (2009) Measurement, reporting and verification for REDD+ Objectives, capacities and institutions, in Angelsen, A. et al. eds., Realising REDD+ National strategy and policy options: Bogor, Indonesia, CIFOR, p. 86-100

## Capacity of implementation countries and possibility of sustained operation

Majority of prospective participating countries in REDD-plus in the future do not have even the capacity to perform basic monitoring, called Tier 1 (see P04) <sup>3), 4)</sup>. This basic monitoring of Tier 1, however, is argued insufficient for implementation of REDD-plus.

Therefore, technology transfers from developed countries are encouraged to promote these countries' readiness for REDD-plus implementation. For this purpose, adequate and predictable supports including financial resources and technical and technological support need to be provided. In addition, the selected technologies should be feasible, taking into account each country's infrastructure and organizational level, and the education level of its population. In many cases, government authorities do not have sufficient number of experienced field workers. One solution is to involve local communities in monitoring activities <sup>5)</sup>; involvement of all stakeholders will also help in the establishment of appropriate safeguards.

Multilateral negotiations regarding funding and REDD-plus credits are still in progress and thus their technical specifications have not yet been consolidated. The use of voluntary certification systems and VER (Verified Emission Reduction) credits, however, is increasing at the project level (see T04). The bilateral offset credit mechanism (BOCM) is a mitigation mechanism similar to project-level certification systems that the Japanese government is designing on the bilateral cooperation basis. For the costs of forest carbon monitoring technology, UNFCCC <sup>6)</sup> should be consulted.

## Construction of a gradual and flexible structure

It has been agreed among the Parties that the REDD implementation structure of each participating country should be gradually consolidated, given many (prospective) participating countries' capacities are still insufficient and REDD-plus funding mechanism is not yet in place.

One concept of gradual and flexible consolidation is the phased approach, by which the organizational level and capabilities of each country will be built up gradually (see P02). Another concept is the stepwise approach <sup>7)</sup>, in which monitoring accuracy will be improved gradually as more data are obtained and expertise increases while a reference level and/or a reference emission level (see P13) can be established preliminarily by using the data initially available.

A forest monitoring system can be also expanded gradually in accordance with REDD-plus priorities, while taking into consideration the circumstances of the participating country <sup>8)</sup>.



# Planning

# 3

## Chapter 3 Basic knowledge needed for REDD-plus implementation





In this chapter, basic terms that must be understood for REDD-plus implementation, such as forest, deforestation, forest degradation, and the "plus" in REDD-plus, are defined and explained. In addition, the phased approach (step-by-step implementation of REDD-plus activities according to each participating country's capabilities and circumstances) and safeguards (to prevent REDD-plus climate change mitigation from having adverse effects on local or indigenous people, the natural environment, or forest governance), both of which were proposed during UNFCCC negotiations, are also explained.

P01 Definitions of forest, deforestation, forest degradation, and the "plus" in REDD-plus

P02 Phased approach

P03 Safeguards

## Definitions of forest, deforestation, forest degradation, and the "plus" in REDD-plus

The preceding Recipe is  
Recipe I02 Key REDD-plus concepts

REDD-plus is a framework that provides economic incentives for reductions in greenhouse gas (GHG) emissions caused by deforestation and forest degradation (REDD), and for conservation of forest carbon stocks, sustainable management of forests, and enhancement of forest carbon stocks (plus). Before methods for calculating emissions and carbon stocks can be presented, the terms "forest", "deforestation", "forest degradation", and the "plus" in REDD-plus need to be defined. At this time, however, final definitions have not been agreed in international REDD-plus negotiations. Therefore, the definition of "forest" and "deforestation" given here are those of the Marrakesh Accords <sup>1)</sup> of the Kyoto Protocol under the United Nations Framework Convention on Climate Change (UNFCCC).

### INFO

1) Marrakesh Accords: At COP 7, held in Marrakech in 2001, agreements were reached on detailed rules, such as Kyoto Mechanisms, required to implement the Kyoto Protocol and compliance rules. The definition of the "forest" is in Article 3, paragraph 3 and 4 and "ARD (afforestation, reforestation and deforestation)" is defined in Article 3, paragraph 3, of the Kyoto Protocol.  
FCCC/CP/2001/13/Add.1 ([http://unfccc.int/methods\\_and\\_science/lulucf/items/3063.php](http://unfccc.int/methods_and_science/lulucf/items/3063.php))

### Forest

The Marrakesh Accords <sup>1)</sup> define a "forest" as follows:

A forest has a minimum land area of 0.05–1.0 hectares with tree crown coverage (or equivalent stocking level) of more than 10–30 percent composed of trees that have a minimum potential height of 2–5 meters at maturity in situ. A forest may be either closed, where trees occupy various levels and undergrowth covers a high proportion of the ground, or open. Young natural stands and all plantations that have yet to reach a crown density of 10–30 percent or a tree height of 2–5 meters are considered forests, as are areas normally forming part of the forest area that are temporarily do not meet these criteria as a result of human intervention such as harvesting or of natural causes but which are expected to revert to forest. Since various types of forests exist in the world, each country may choose specific values of tree height, tree crown cover rate, and minimum area within the above criteria.

### Deforestation

The Marrakech Accords define "deforestation" as direct human-caused conversion of forested land to non-forested land. When elements required to meet the definition of "forest" are lost as a result of reclaiming forest for agricultural land, mining of underground resources, or construction of cities, villages, and roads, it is deemed "deforestation."

## Forest degradation

"Forest degradation" is defined as changes that affect forest production or forest ecosystem function or adversely affect the structure or function of the forest. From the viewpoint of providing economic incentives for emission reductions, forest degradation is considered to be a decrease of forest carbon stocks. However, forest carbon stocks vary as a result of periodic natural disturbances and forest management practices such as periodic timber harvests. In addition, international agreement on the definition of forest degradation has not yet been reached.

## The "plus" in REDD-plus

The 13<sup>th</sup> Conference of the Parties (COP 13) under the UNFCCC agreed to add the "plus" - conservation, sustainable management of forests, and enhancement of forest carbon stocks - in REDD-plus. The Marrakesh Accords define forest management as a series of actions that are undertaken to conserve a sustainable forest ecosystem (including biodiversity) and which take into account economic considerations and social functioning. However, the definition has not been concrete. Therefore, it is interpreted differently by the nations that ratified the Kyoto Protocol, depending on their national forest management practices. International agreement on the definitions of the conservation, sustainable management of forests, and enhancement of forest carbon stocks have not been reached, either. Further discussions on their definitions are needed.

The definitions of forest, deforestation, forest degradation, and the "plus" in REDD-plus, which are essential for evaluating the outcome of REDD-plus, have yet to be established. The definitions chosen should be simple, for smooth implementation of REDD-plus, and their definitions may differ from country to country.

### Bibliography

GOFC-GOLD (2011) A sourcebook of methods and procedures for monitoring and reporting anthropogenic greenhouse gas emissions and removals caused by deforestation, gains and losses of carbon stocks in forests remaining forests, and forestation: GOFC-GOLD Report version COP17-1. GOFC-GOLD

## Phased approach

The preceding Recipe is

Recipe I02 Key REDD-plus concepts

REDD-plus is a framework for reducing greenhouse gas (GHG) emissions and increasing greenhouse gas absorption through forest-related activities by developing countries. Implementation of REDD-plus requires measurement, reporting, and verification (MRV), and positive incentives will be provided to participating countries based on their performance. The implementation of REDD-plus in developing countries must take into consideration their national circumstances and capabilities, both technical and institutional. The "phased approach" defines the steps that should be taken to prepare countries for full implementation of REDD-plus. This phased approach concept was first put forward at the REDD-plus workshop held by the Ad Hoc Working Group (AWG) at the Accra Climate Change Conference in August 2008 by Papua New Guinea, which initiated a request to consider allowing REDD-plus to be implemented in three phases <sup>1)</sup>. Since then, a phased approach has been recognized as a basic element of REDD-plus. In this chapter, the phased approach, as laid out in the Cancun Agreements <sup>2)</sup>, which form the basis of current REDD-plus negotiations, is explained.

### INFO

1) UNFCCC (2008) FCCC/AWGLCA/2008/CRP.5, UNFCCC

### INFO

2) UNFCCC (2011) FCCC/CP/2010/7/Add.1, UNFCCC

## Phase 1: Readiness

As stated in the Cancun Agreements <sup>2)</sup>, implementation of REDD-plus should begin "with the development of national strategies or action plans, policies and measures, and capacity-building (Figure P02-1)." These will form the basis not only for successful implementation of REDD-plus but also for addressing any policy issues; therefore, it is vital for all countries to develop appropriate strategies and plans in Phase 1.

The national strategies or action plans, policies, and measures for REDD-plus should be developed in a way that is consistent with each respective country's development goals, land-use planning, and forest planning. Otherwise, confusion will result during the implementation REDD-plus. To avoid such confusion, it is dispensable to balance policies by considering the relevant levels of government and the stakeholders.

The Cancun Agreements stipulate that in the development and implementation of a national strategy and action plan for REDD-plus, the drivers of deforestation and forest degradation, land tenure issues, forest governance issues, gender considerations, and the safeguards should be taken into account, and the participation of all stakeholders should be secured (see P03). These processes are integral to the implementation of emission reduction activities through REDD-plus.

Capacity-building is vital during policy development and REDD-plus implementation, and it is important to clarify the challenges and targets of capacity-building. Capacity-building includes technical training on the MRV

system, monitoring methods, and the establishment of reference levels, and the development of policymaking and law enforcement capabilities. Capacity-building aims to foster expertise and to train members of REDD-plus participating organizations and relevant stakeholders to address their respective challenges. Members of concerned organizations, especially government organizations, and stakeholders are considered to be the targets of capacity building. Local communities, members of the private sector, consultants, NGOs, and educational institutions, all of which are important stakeholders, are also potential targets.

It should be noted that Phase 1 is not merely the phase preceding Phases 2 and 3. The readiness activities of Phase 1 should continue throughout REDD-plus implementation (Figure P02-1).

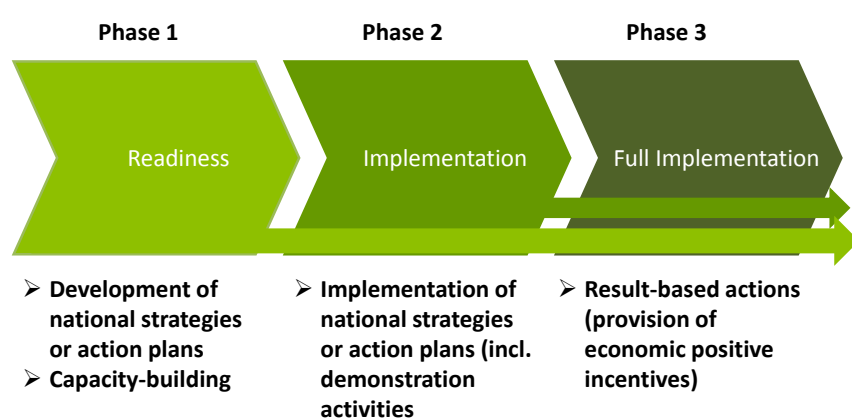

Figure P02-1 Flow of the phased approach

## Support for readiness phase

Phase 1 activities constitute the foundation of REDD-plus implementation, and they should be continuously modified and improved in response to new developments. However, carrying out this phase is technically and financially challenging for most developing countries. The Readiness Fund of the Forest Carbon Partnership Facility (FCPF), a World Bank programme, and the UN-REDD, a United Nations collaborative initiative among the Food and Agriculture Organization (FAO), the U. N. Development Programme (UNDP), and the U. N. Environment Programme (UNEP), are frameworks already in place for supporting the readiness phase through financial and technical aid. National strategies and action plans for REDD-plus, including an annual implementation schedule by subject, budget, and supporting countries and organizations, have already been developed by some countries. These can serve as useful references for other countries seeking to move into the first,

readiness phase.

Multilateral and bilateral technical assistance projects conducted by developed countries, interested international organizations, and NGOs will facilitate REDD-plus activities. Official development assistance agencies, such as JICA (Japan International Cooperation Agency), GIZ (German Agency for International Cooperation), or USAID (United States Agency for International Development), which implement technical assistance projects, have a vast amount of technical knowledge and experience, which can be effectively used to assist developing countries in Phase 1 activities.

Moreover, developed countries are obliged to submit an annual inventory report on the amount of emissions and removals from the LULUCF sector based on the Kyoto Protocol under the UNFCCC (see P05). Annual inventory reports are technically similar to REDD-plus reports regarding forest greenhouse gas emissions and removals. Accordingly, these reports also can serve as good reference material.

## Phase 2: Implementation

Following Phase 1, readiness, the Cancun Agreements specify Phase 2, "the implementation of national policies and measures and national strategies or action plans that could involve further capacity-building, technology development and transfer and result-based demonstration actions". This is a preparation phase between the readiness phase and the final phase of full implementation.

Phase 2 includes "demonstration activities" as a new element. "Demonstration activities" were first introduced in the Bali Action Plan at COP 13 "to address the drivers of deforestation relevant to their national circumstances, with a view to reducing emissions" <sup>3)</sup>. Its elements are shown under "Indicative Guidance" in ANNEX. Phase 2 should take these elements into account to prepare for the final implementation of "activities based on the fully measured, reported, and verified results".

The Carbon Fund of the World Bank's Forest Carbon Partnership Facility will be one of the major sources of support for Phase 2 implementation. In addition, Phase 2 elements such as the "demonstration project" may be included in bilateral technical assistance projects carried out by developed countries in some cases. Therefore, these projects are expected to be further developed and implemented.

### INFO

3) UNFCCC (2008) FCCC/CP/2007/6/Add.1, UNFCCC

### Phase 3: Full implementation

---

The Cancun Agreements specify that in the final phase of REDD-plus, "results-based actions that should be fully measured, reported and verified". It is understood that incentives will be provided if greenhouse gas emission reductions and removals are attained as a result of REDD-plus activities provided that they are fully measured, reported, and verified in a manner recognized as credible.

Currently, most REDD-plus participating countries are still in Phase 1 or Phase 2. Few, if any, have reached the final phase. Unlike other sectors such as the transport sector, REDD-plus implementation faces many challenges, including limited technology, data, organization, and human resources. Moreover, the target areas, which are characterized by diverse tree species with varying growth rates, are affected by weather, which can also delay full implementation of REDD-plus.

Although there is no way to avoid dealing with these challenges, it is possible to make them less daunting by implementing REDD-plus first at the sub-national level. Implementation at the sub-national level allows resources to be concentrated in a particular region, and early implementation regions can serve as examples of good practice when implementation is expanded at the national level. In addition, it is crucial for stakeholders and supporting countries and institutions to liaise closely to ensure that a certain level of agreement is reached.

## Safeguards

The preceding Recipe is

Recipe I03 Measurement, reporting and verification (MRV) of forest monitoring

The 16<sup>th</sup> Conference of the Parties (COP 16) agreed on promoting and supporting "the safeguards" in REDD-plus, and the principles are listed in Appendix I of the Cancun Agreement. The Forest Carbon Partnership Facility (FCPF) of the World Bank and the UN-REDD Programme also request their partners to address environmental and social safeguards. While specific requirements for "the safeguards" have not yet been clarified in the United Nations Framework Convention on Climate Change (UNFCCC) negotiations, the FCPF, the UN-REDD Programme, and NGOs are developing their own principles, criteria, indicators, and guidelines regarding safeguards.

### Safeguards in REDD-plus

Safeguards are policies and measures designed to prevent risks of impairing effects of climate change mitigation measures as REDD-plus (such as increasing greenhouse gas emissions in another forms and places or resulting in effects of emission reductions and increased absorption to be a temporary) and negative impacts on forest governance, the natural environment, and society, and to enhance positive effects. Safeguards are an important feature of the REDD-plus framework.

### The safeguards in the UNFCCC

The Cancun Agreement <sup>1)</sup>, adopted at COP 16 in 2010, stipulates that "the safeguards" should be promoted and supported in accordance with the principles listed in the agreement (Table P03-1). The safeguards cover a range of issues such as forest governance and social, environmental, and climate concerns <sup>2)</sup>. These issues were also addressed before COP 16 in the provisions of various agreements. By listing these principles they have been made clear and accessible to stakeholders of REDD-plus participating countries.

Moreover, the agreement requests developing countries to develop a system for providing information on how the safeguards are being addressed and respected, and also requests that developing countries secure the full and effective participation of stakeholders, including indigenous peoples and local communities, when developing and implementing national strategies and action plans for addressing "the safeguards" (Table P03-2).

#### INFO

1) UNFCCC (2011) Decision 1/CP.16, FCCC/CP/2010/7/Add.1, UNFCCC

#### INFO

2) This classification is used here for convenience; it is not based on the UNFCCC.



Table P03-1 Safeguards in the Cancun Agreement  
(after UNFCCC (2011)<sup>1)</sup>)

Safeguards	Category <sup>*)</sup>
(a) Actions should complement or be consistent with the objectives of national forest programs and relevant international conventions and agreements	Forest governance
(b) National forest governance structures should be transparent and effective, taking into account national legislation and sovereignty	
(c) Actions should respect for the knowledge and rights of indigenous peoples and members of local communities, by taking into account relevant international obligations, national circumstances and laws, and noting that the United Nations General Assembly has adopted the United Nations Declaration on the Rights of Indigenous Peoples	Social
(d) The relevant stakeholders, in particular indigenous peoples and local communities, should fully and effectively participate in the actions referred to in paragraphs 70 and 72 of this decision	
(e) Actions should be consistent with the conservation of natural forests and biological diversity, ensuring that the actions referred to in paragraph 70 of this decision are not used for the conversion of natural forests, but are instead used to incentivize the protection and conservation of natural forests and their ecosystem services, and to enhance other social and environmental benefits	Environmental/ Social
(f) Actions should be taken to address the risks of reversals	Climate
(g) Actions should be taken to reduce displacement of emissions	

Note: \*) "Category" is the author's grouping, not UNFCCC's.

Table P03-2 Paragraphs related to the safeguards in Cancun Agreement  
(after UNFCCC (2011)<sup>1)</sup>)

Paragraph	
69	<i>Affirms</i> that the implementation of the activities referred to in paragraph 70 below should be carried out in accordance with appendix I to this decision, and that the safeguards referred to in paragraph 2 of appendix I to this decision should be promoted and supported
71(d)	<i>Requests</i> developing country Parties aiming to undertake the activities referred to in paragraph 70 above, in the context of the provision of adequate and predictable support, including financial resources and technical and technological support to developing country Parties, in accordance with national circumstances and respective capabilities, to develop the following elements:  (d) A system for providing information on how the safeguards referred to in appendix I to this decision are being addressed and respected throughout the implementation of the activities referred to in paragraph 70 above, while respecting sovereignty
72	<i>Also requests</i> developing country Parties, when developing and implementing their national strategies or action plans, to address, inter alia, the drivers of deforestation and forest degradation, land tenure issues, forest governance issues, gender considerations and the safeguards identified in paragraph 2 of appendix I to this decision, ensuring the full and effective participation of relevant stakeholders, inter alia indigenous peoples and local communities

## Social and environmental safeguards

Social and environment safeguards in particular have been a topic of much discussion.

Social safeguards in the agreement (Table P03-1) provide for (c) respect for the knowledge and rights of indigenous peoples and members of local communities; (d) the full and effective participation of relevant stakeholders, in particular, indigenous peoples and local communities; and (e) enhancement of other social and environmental benefits, including consideration of gender and vulnerable groups, contributions to sustainable development, and promotion of poverty alleviation. Environmental safeguards stipulate that (e) REDD-plus actions should be consistent with the conservation of natural forests and biological diversity, and should be used to incentivize protection and conservation of natural forests and their ecosystems services, as well as to enhance other social and environmental benefits (Table P03-1).

Note that the terms "environmental safeguards" and "social safeguards" are not defined in the UNFCCC document. At this time, the specific field activities protected by safeguards often depend on the project planner's interpretation of the agreement.



Figure P03-1 Forest management by local community  
upper: discussion on management of community forest  
lower: community forest

## Effects and significance of safeguards

Ensuring that safeguards are respected will also enhance the feasibility of REDD-plus activities and their effective implementation, because by solving social conflicts and reducing political risk in the participating country, investment by domestic and international markets will increase. In addition, outside the UNFCCC framework, voluntary initiatives such as the World Bank's FCPF and the United Nations Collaborative Programme on Reducing Emissions from Deforestation and Forest Degradation in Developing Countries (UN-REDD Programme) place the highest priority in ensuring environmental and social safeguards. It is highly possible that addressing environmental and social safeguards will be made a requirement for carbon offsetting with credits generated by REDD-plus activities.

## Institutional challenge for ensuring safeguards

The UNFCCC has not yet decided how differences in safeguards due to differences in each country's circumstances should be handled. Although the document "Guidance on systems for providing information on how safeguards are addressed and respected", adopted at COP 17 in 2011, provides basic guidelines <sup>3)</sup>, it does not elaborate on what should be reported. Given that situation, the FCPF, the UN-REDD Programme, and NGOs have been voluntarily developing their own principles, criteria, and indicators as well as guidelines for social and environmental safeguards <sup>4)</sup>. Safeguards should be addressed by taking these voluntary efforts into consideration, while also closely watching development in the ongoing discussions.

### INFO

3) UNFCCC (2012) Decision 12/CP.17, FCCC/CP/2011/9/Add.2, UNFCCC

### INFO

4) Several standards are available : The "Strategic Environmental and Social Assessment (SESA)" by the World Bank; the "UN-REDD's Social and Environmental Principles and Criteria (SEPC)" by the UN-REDD Programme; the "REDD-plus Social and Environmental Standards (REDD-plus SES)" and the "Climate, Community and Biodiversity Standards (CCBS)" by NGOs.

# 4

## Chapter 4 Measurement, reporting and verification of forest carbon



Credible measurement, reporting, and verification (MRV) of climate change mitigation actions is crucial in REDD-plus. MRV may be required as part of the accounting of all removals and emissions of greenhouse gases from forests and applied to implement REDD-plus rules. This chapter focuses on each component of MRV with regard to changes in forest carbon, which are used to estimate removals and emissions of CO<sub>2</sub>.

Although REDD-plus is designed for eventual implementation at the national level, voluntary initiatives at the project level have been gaining momentum. Therefore, the recipes on reporting (P05) and verification (P06) in this chapter also include information that should be taken into consideration at the project level.

P04 Measurement of forest carbon

P05 Reporting of forest carbon

P06 Verification of forest carbon

## Measurement of forest carbon

The preceding Recipe is

Recipe I03 Measurement, reporting and verification (MRV) of forest monitoring

Measurement of forest carbon is a vital part of REDD-plus implementation because CO<sub>2</sub> emission reductions and removals from forests are estimated by measuring changes in the amount of forest carbon, and credits are also calculated by using the forest carbon amount. This recipe explains what is measured and how to measure it, based on the United Nations Framework Convention on Climate Change (UNFCCC) decisions and Intergovernmental Panel on Climate Change (IPCC) 2006 Guidelines.

### INFO

1) Tier: the level at which the amount of emissions is measured (2006 IPCC Guidelines).

Tier 1 is the simplest and most basic, and Tier 3 is the most complex and requires a great deal of data. Tier 2 is intermediate between Tiers 1 and 3. When the amount of emissions from a certain sector of a country is a core element (i.e., the absolute quantity, tendency, or uncertainty in the amount of emissions in that sector is remarkable), then Tier 2 or Tier 3 should be used.

In the Agriculture and Forestry and Other Land Use (AFOLU), Tier 1 emissions estimates are made by using the gain-loss method and utilizing default IPCC emission factors. At higher tiers, emissions are estimated by using the gain-loss method or the stock-change method and the emission factors are determined in situ.

For REDD-plus, it is not yet decided which tier should be used for emissions estimates. Because the AFOLU default emission factors have very high uncertainty, some are of the opinion that Tier 1 should not be used, and a discount should be given for using the conservative factors of AR/D CDM . On the other hand, very few developing countries have the capability to implement REDD-plus even at Tier 1 (see I04). For this reason, the phased approach, taking account of capacity-building, is the most feasible for developing countries (see P02).

### What to measure?

REDD-plus activities are carried out in forests, where "forest" can be defined by each participating country as far as within the margin set by the UNFCCC (see P01). To reduce uncertainties in the estimation of emissions, it is recommended that the total forest area be divided into subclasses of forest, depending on the ecological, legal, economic, cultural, and/or other situations in a particular country. For example, by subdividing a forest by forest type or by the degree of disturbance and then estimating the carbon stock by each subclass, the uncertainty will be lower than if it is estimated to the whole forest.

Land use in the forest is divided into two categories: managed land and unmanaged land. "Managed land" is land where human interventions and practices have been applied to perform production, ecological or social functions, and all other land is classified as "unmanaged". Although REDD-plus includes the role of conservation by definition, a specific definition has not yet been decided (see P01).

A component of a land use that store, absorb and/or emit carbon is called pool. For forest, five pools are defined, namely, above-ground biomass, below-ground biomass, dead wood, litter and soil organic matter (See T02). Greenhouse gases (GHGs) other than CO<sub>2</sub>, such as CH<sub>4</sub> and N<sub>2</sub>O, are subject to measurement in accordance with the principle of completeness (see I03). However, the impact of each pool on carbon stocks, and accordingly the appropriate tier, depends on the size of the pool and the greenhouse gases being measured <sup>1)</sup>. In general, measurements of the above-ground and below-ground biomass require higher tiers, since their changes greatly affect CO<sub>2</sub> emissions and removals in forests, while lower tiers for other pools due to their relatively low affects (See T02).

### How to measure?

The UNFCCC recommends the use of remote sensing and ground-based

forest carbon inventory approaches in combination to estimate forest carbon stocks for REDD-plus <sup>2)</sup>.

Two methods are available for estimating the amount of forest carbon change in a pool: the gain-loss method and the stock change method (see P07). In the gain-loss method, increases (gains) and decreases (losses) in the amount of carbon in the pool from various causes are first estimated and summed. Then their difference (gains minus losses) is the amount of change in the pool (equation P04-1). For example, the increase caused by the growth of biomass, the decrease caused by withering, and increases and decreases caused by land-use changes are accumulated:

$$\Delta C = \Delta C_G - \Delta C_L \quad (\text{P04-1})$$

where,

$\Delta C$  : the amount of annual carbon change in the pool (t-C/year)

$\Delta C_G$  : the amount of annual carbon increase (t-C/year),

$\Delta C_L$  : the amount of annual carbon decrease (t-C/year).

In the stock change method, the amount of forest carbon is estimated in two different years, and the amount of forest carbon change is estimated from the difference in forest carbon between the years (equation P04-2) (see P07) :

$$\Delta C = \frac{C_{t_2} - C_{t_1}}{t_2 - t_1} \quad (\text{P04-2})$$

where,

$\Delta C$  : the amount of annual carbon change in the pool (t-C/year)

$C_{t_1}$  : the amount of carbon (t-C) in  $t_1$  (year)

$C_{t_2}$  : the amount of carbon (t-C) in  $t_2$  (year)

The amount of carbon stocks in a certain year is calculated by measuring the carbon stocks per unit area and then multiplying that amount by the total area of the forest (or forest subdivision).

The gain-loss method, can be used to estimate biomass at all tiers (Tiers 1–3), where as the stock change method is used only at Tiers 2 and 3, because it is more accurate when the amount of carbon change has been relatively large. Later in this cookbook, the stock change method is described in detail; P08 explains the area and area change estimations by using remote sensing, while P09 explains the estimation of forest carbon stock per unit area by ground measurements and/or alternative methods.

#### INFO

2) UNFCCC (2009) Decision 4/CP.15, FCCC/CP/2009/11/Add.1, 11-12, UNFCCC

## Reporting of forest carbon

The preceding Recipe is

Recipe I03 Measurement, reporting and verification (MRV) of forest monitoring

"Reporting" means providing information about the mitigation activities and their performances in a prescribed manner so as to make them comparable with other efforts. The modality of "reporting" on REDD-plus activities under the United Nations Framework Convention on Climate Change (UNFCCC) has not yet been agreed. In this recipe, the status of international negotiations on the reporting of greenhouse gas (GHG) emissions and removals at the national level is reviewed and basic requirements and considerations required for reporting greenhouse gas emissions and removals in the forest sector are explained.

### What is reporting?

"Reporting" means providing information about estimated emissions and removals, estimation methods, procedures, and systems, including present conditions and future projections in accordance with the prescribed reporting guidelines, formats, and procedures, to designated organizations. Reporting enable comparison of emission reductions and removals and ensures transparency.

The requirements of reporting are different depending on whether REDD-plus is implemented at the national level under the UNFCCC or at the project level under clean development mechanism (CDM) or another voluntary certification scheme. In this section, the reporting requirements for implementations at the national level are outlined.

### National communications

Article 4, paragraph 1 of the UNFCCC specifies that "All Parties, taking into account their common but differentiated responsibilities and their specific national and regional development priorities, objectives and circumstances, shall: (a) Develop, periodically update, publish and make available to the Conference of the Parties, in accordance with Article 12, national inventories of anthropogenic emissions by sources and removals by sinks of all greenhouse gases not controlled by the Montreal Protocol, using comparable methodologies to be agreed upon by the Conference of the Parties, and (b) Formulate, implement, publish and regularly update national and, where appropriate, regional programmes containing measures to mitigate climate change by addressing anthropogenic emissions by sources and removals by sinks of all greenhouse gases not controlled by the Montreal Protocol, and measures to facilitate adequate adaptation to climate change."



Article 12 specifies the information that must be reported and the timetable for its submission. All Parties are required to submit a national inventory of anthropogenic greenhouse gases and the relevant measures to achieve the ultimate objective of the Convention. In addition, Annex I Parties are required to include climate-related policies and measures, greenhouse gas projections, and support to the non-Annex I Parties. Each report is called a "national communication" (NC). Annex I parties must submit an initial national communication within six months of the entry into force of the Convention for that Party, and non-Annex Parties must submit an initial national communications within three years. The frequency of subsequent submissions should be determined according to COP decision <sup>1)</sup>.

As of June 2012, most Annex I Parties have submitted their fifth or sixth national communications. The 16<sup>th</sup> Conferences of the Parties (COP 16) calls for submission of the sixth national communications on 1 January 2014. Among non-Annex I Parties, 146 have submitted initial national communications, 74 have submitted their two and three have submitted three national communications <sup>2)</sup>. The timetable for submissions by other non-Annex I Parties and the need to increase their capability level for national communications submission are still being discussed at COP.

To facilitate the submissions of national communications from non-Annex I Parties, a user manual <sup>3)</sup> and a resource guide containing more detailed instructions on the procedure have been provided by the UNFCCC.

## National greenhouse gas inventory

A national greenhouse gas inventory consists of estimates of emissions and removals of greenhouse gases by sector. Non-Annex I Parties must submit a national inventory as a part of their national communications.

According to the UNFCCC reporting guidelines on annual inventories, the Annex I Parties are required, by 15 April each year, to provide annual national greenhouse gas inventories covering emissions and removals of direct greenhouse gases (CO<sub>2</sub>, CH<sub>4</sub>, N<sub>2</sub>O, HFCs, PFCs, and SF<sub>6</sub>) from six sectors (Energy, Industrial processes, Solvents, Agriculture, LULUCF (land use, land-use change and forestry), and Waste) for all years from the base year or period to the most recent year.

Under the UNFCCC reporting guidelines for the Annex I Parties, inventory submissions have two parts:

- Common reporting format (CRF) <sup>4)</sup> – a series of standardized data tables containing mainly numerical information and submitted electronically
- National Inventory Report (NIR) – a comprehensive description of the methodologies used in compiling the inventory, the data sources,

### INFO

1) Decision 17/CP.8 Guidelines for preparation of national communications from Parties not included in Annex I of the Convention: UNFCCC (2003) Decision 17/CP.8, Guidelines for the preparation of national communications from Parties not included in Annex I to the Convention, FCCC/CP/2002/7/Add.2 <http://unfccc.int/resource/docs/cop8/07a02.pdf#page=2>

### INFO

2) Non-Annex I national communications : [http://unfccc.int/national\\_reports/non-annex\\_i\\_natcom/items/2979.php](http://unfccc.int/national_reports/non-annex_i_natcom/items/2979.php)

### INFO

3) Reporting on Climate Change: user manual for the guidelines on national communications from non-Annex I Parties : [http://unfccc.int/files/essential\\_background/application/pdf/userman\\_nc.pdf](http://unfccc.int/files/essential_background/application/pdf/userman_nc.pdf)

### INFO

4) CRF of the LULUCF sector of Annex I Parties : UNFCCC (2005) Decision 14/CP.11, Tables of the common reporting format for land use, land-use change and forestry

the institutional structures, and the quality assurance and control procedures

The inventory submissions are reviewed by international expert review teams (ERTs) based on the agreed review guidelines.

The estimation method should be based on the IPCC guidelines agreed by COP. The non-Annex I Parties should use the IPCC guidelines as revised in 1996, and the Annex I Parties are required to use the Good Practice Guidance for LULUCF (GPG-LULUCF) published in 2003. Annex I Parties that have made an emissions reduction target pledge under Article 3 of the Kyoto Protocol are required to provide supplementary information related to the emissions and removals of greenhouse gases in the areas subjected to activities under Article 3, paragraph 3, and the elected activities under paragraph 4 of the Kyoto Protocol <sup>5)</sup>. The supplementary information includes the geographical locations of the boundaries of the areas that encompass lands subjected to activities under Article 3, paragraphs 3 and 4, and a demonstration that these activities are human induced. In-depth reviews are also conducted by an international team of experts from the Annex I and non-Annex I Parties, selected from the roster of experts. If deficiencies or incompleteness are identified in the reports, the Parties that submitted the report will receive a "recommendation for improvement". If the Parties fail to improve the indicated parts before the due date, an "adjustment" will be performed by the expert review team. If the amount of adjustment exceeds a certain level, penalties, including suspension of eligibility for the Kyoto mechanism, will be imposed.

#### INFO

5) UNFCCC (2007) Decision 6/CMP.3, Good practice guidance for land use, land-use change and forestry activities under Article 3, paragraphs 3 and 4, of the Kyoto Protocol

#### INFO

6) UNFCCC (2010) Decision 2/CP.17, Outcome of the work of the Ad Hoc Working Group on Long-term Cooperative Action under the Convention, paragraph 39-44, UNFCCC biennial update reporting guidelines for Parties not included in Annex I to the Convention

#### INFO

7) Form: Chapter 3, Annex 3 in GPG-LULUCF : [http://www.ipcc-nggip.iges.or.jp/public/gpplulucf/gpplulucf\\_files/Chp3/Anx\\_3A\\_2\\_Reporting\\_Tables.pdf](http://www.ipcc-nggip.iges.or.jp/public/gpplulucf/gpplulucf_files/Chp3/Anx_3A_2_Reporting_Tables.pdf)

### Biennial update reports/International consultation and analysis

In 2010, in order to promote mitigation actions by developing country Parties based on "nationally appropriate mitigation actions of the developing country Parties (NAMA)", the Parties agreed at COP 16 that developing country Parties should submit national communications every four years and biennial update reports (BURs) <sup>6)</sup>, which include inventory reports, the steps the countries are taking for mitigation actions, and support needed from developed country Parties, are required to go through "International Consultation and Analysis" (ICA). The submission date and contents of the biennial update reports are determined based on the guidelines for biennial update reports agreed by COP 17 in 2011. The developing country Parties should submit an initial biennial update report by December 2014, and it should be updated every two years. Each biennial update report must cover, at minimum, the inventory for the calendar year no more than four years prior to the date of the submission, or for a more recent year if information is

available, and subsequent biennial update reports shall cover a calendar year that does not precede the submission date by more than four years.

The inventory included in biennial update report should be calculated and reported based on the 1996 guidelines, GPG2000, and GPG-LULUCF, and for the LULUCF sector, the use of the form specified in GPG-LULUCF Chapter 3, Annex 3<sup>7)</sup>, is recommended.

COP 17 also agreed on the modality and guidelines for International Consultation and Analysis. The agreement specifies that the first round of International Consultation and Analysis shall be conducted within six months of the submission of the initial biennial update report and the modality and guidelines<sup>8)</sup> will be revised no later than 2017 on the basis of the experience gained in the first round of International Consultation and Analysis. Discussions about the team of technical experts that will perform International Consultation and Analysis and other details are still in progress.

#### INFO

8) UNFCCC (2010) Decision 2/CP.17, Outcome of the work of the Ad Hoc Working Group on Long-term Cooperative Action under the Convention, paragraph 56-62, Modalities and guidelines for international consultation and analysis

## Reporting requirements

The reporting requirements of REDD-plus under measurement, reporting and verification (MRV) have not yet been agreed. Therefore, a detailed explanation of the reporting requirements is not included in this chapter. Future discussions on the contents and procedures of national communications and biennial update reports should be carefully followed, since they will influence the reporting requirements of REDD-plus under MRV and how REDD-plus activities should be carried out at different implementation levels of either national or project.

Five principles, namely, transparency, accuracy, comparability, completeness, and consistency, are essential for the reporting of greenhouse gas emissions and removals, regardless of the implementation level or whether the country is developed or developing. To ensure that these principles are followed in the reporting of forest carbon, it is important to rigorously specify all elements of the estimation method used, including the definition of forest, the main forest stratification, and the main parameters, and to maintain consistency among various reports.

Unlike other emission sectors, the situation in LULUCF sector varies greatly among Parties, with regard to the specific aspects of the natural environment and ecosystem complexity. For reliable reporting, it is important to provide quantitative information, including about emissions and removals of greenhouse gases, and to clearly and fully present qualitative information about the natural environment, the social and economic situation, and the estimation process, as well as justification for using the selected method, taking into account the different circumstances of each country.

## Verification of forest carbon

The preceding Recipe is

Recipe I03 Measurement, reporting and verification (MRV) of forest monitoring

"Verification" in the context of MRV of greenhouse gas (GHG) emissions and removals is a procedure for assessing and ensuring, from an independent standpoint, the reliability of the reporting of estimations, and the adequacy of methods, procedures, and documentation. This process is a prerequisite for the policy effect evaluation based on the greenhouse gas inventory and the trade of the credits produced by emission reduction projects. However, verification is often hampered by limited availabilities of funds, human resources, and data. Such limitations are particularly pronounced in the forest sector including REDD-plus, where a verification method that is feasible, within these limitations, and effective, considering the nature of the forest sector, and that also achieves these purposes should be selected. Although an international agreement has not yet been reached on the modality of verification of REDD-plus activities, it is likely that it would reflect experiences from the precedent forest-related emission reduction mechanisms such as the clean development mechanism (CDM), while taking into account peculiarities of REDD-plus.

### What is verification?

In general, "verification" is defined as a "process to confirm that the specified requirements are fulfilled by presenting objective evidence." Verification is essential both in the case of reported national greenhouse gas inventory data under the United Nations Framework Convention on Climate Change (UNFCCC) and for reporting at project level under the CDM and other voluntary carbon credit systems. The verification requirements and procedures, however, vary depending on the purpose of the reported calculations and the structure of the report.

For national greenhouse gas inventory reporting under the UNFCCC, verification is performed by using quality control (QC) and quality assurance (QA) procedures, either by those directly involved in the calculation or by a third party. The adequacy of the selected activity data and parameters and the estimation method are assessed by comparisons with other data sets and/or inventories submitted by neighboring countries. On the other hand, under the credit trading mechanism, such as the CDM or a voluntary carbon credit system, the verification is a part of an ex-post assessment process that confirms the emission reductions that the project has attained and the reliability of the carbon credits. This verification must be done by a third party to confirm that the project has been conducted according as prescribed in the project plan.

## Verification requirements and procedures

When performing verification, it is important to know the requirements and procedures specified by the designated reporting scheme. Verification of national greenhouse gas inventory reports is based on Intergovernmental Panel on Climate Change (IPCC) guidelines (2006 IPCC Guidelines, volume 1, chapter 6; QA/QC and Verification) or IPCC Good practice guidance (IPCC Good practice guidance and uncertainty management in national greenhouse gas inventories and greenhouse gas for land use, land-use change and forestry (GPG-LULUCF)). In the case of the CDM, verification is based on the modality and procedure agreed by COP and a manual recognized by the CDM executive board. If it is a project-level framework assuming credit trades, the verification should be based on the respective guidelines established by each credit-trading framework in addition to the IPCC guidelines. The EU Emissions Trading System (ETS) and the Verified Carbon Standard (VCS) have developed specific guidelines for verification that comply with international standards such as ISO14064-3, established by the International Standardization Organization (ISO). In many cases under the system developed for credit trading purposes, a certification system pursuant to ISO14065 is used to ensure the ability of the third parties that conduct the verification.

## Basic approach to verification in the forest sector

Estimations of emission reductions and removals for verification are based on IPCC guidelines. Because limited technical and financial resources are available for verification, priorities must be established for determining the target and approaches to be verified. For national greenhouse gas inventory reporting, relevance is the main criterion: the results of key category analysis and the uncertainty of each category and greenhouse gas are assessed, and items with higher relevance or uncertainty (see P12) are prioritized for the verification.

The approaches should be selected based not only on their feasibility or adequacy taking national or regional circumstances into account but also on the degree of interest, cost, the level of required accuracy, complexity in planning and implementing verification approach, and the required level of expertise.

Applicable approaches for the verification in the LULUCF sector are: (1) comparison with other inventories and independent data sets, (2) overall or partial comparison with the estimations obtained at a higher tier, (3) direct measurement, (4) remote sensing, and (5) modeling. (IPCC GPG-LULUCF)

(1) and (2) are the most commonly used methods as they can be carried out at relatively low cost and do not require special technology or knowledge as long as an independent data set are available. The cost, human resources, and expertise required for (3), (4), and (5) vary significantly depending on the implementation method. The applicability of verification approaches for land area identification and for carbon pools and gases in the LULUCF sector is indicated in Table 5.7.1 of GPG-LULUCF.

## Verification of REDD-plus activities

An international agreement has not yet been reached on the modality of verification of REDD-plus activities, but their verification is indispensable to ensure reliability and fairness because financial incentives are provided based on the achieved emission reductions and removals. It is likely that for project-level efforts aimed at credit trading the verification is to be conducted by a third party, based on the experience gained by the CDM or other voluntary credit certification systems.

Verification criteria for REDD-plus have not yet been decided. Further discussions will establish the design of the future system of REDD-plus verification based on in situ experience and by considering the following points:

- Which implementation level is introduced; national, sub-national, or project level?
- Have boundaries been appropriately determined (project areas, reference area, leakage belts, etc.)?
- Have an appropriate scenario and data been used to establish baselines (reference levels), considering the drivers of deforestation and forest degradation?
- Has the monitoring system been properly developed (including with the participation of indigenous and local communities)?

Future discussions will also focus on the effectiveness of emission reduction activities such as forest conservation, impacts on ecosystems, especially biodiversity, and socio-economic impacts, and how safeguards are addressed and respected.

Table P06-1 Applicability of verification approaches for land area identification and for carbon pools and non-CO<sub>2</sub> greenhouse gases (excerpt from GPG-LULUCF 5.7.1)

	<b>Approach 1</b> <b>Comparison with inventories and other independent data sets</b>	<b>Approach 2</b> <b>Applying higher tier methods</b>	<b>Approach 3</b> <b>Direct measurement</b>	<b>Approach 4</b> <b>Remote sensing</b>	<b>Approach 5</b> <b>Modelling</b>
<b>Land area</b>	Suitable, if data are available	Suitable, if data are available	Not applicable	Suitable	Not applicable
<b>Carbon pools</b>					
Above-ground biomass	Suitable, if data are available	Suitable, if data are available	Suitable (resource-intensive)	Suitable (ground data needed)	Suitable, (regression, ecosystem and growth models)
Below-ground biomass	Suitable, if data are available	Suitable, if data are available	Suitable (resource-intensive)	Not applicable	Suitable, (regression, ecosystem and growth models)
Dead wood	Suitable, if data are available	Suitable, if data are available	Suitable (resource-intensive)	Not applicable	Applicable (ecosystem and inventory-based models)
Litter	Suitable, if data are available	Suitable, if data are available	Suitable (resource-intensive)	Not applicable	Applicable (ecosystem and inventory-based models)
Soil organic matter	Suitable, if data are available	Suitable, if data are available	Suitable (resource-intensive)	Not applicable	Suitable (ecosystem and inventory-based models)
<b>Non-CO<sub>2</sub> greenhouse gases</b>	Suitable, if data are available	Suitable, if data are available	Suitable (resource-intensive)	Not applicable	Suitable (ecosystem models)
<b>Emission factors</b>	Suitable, if data are available	Suitable, if data are available	Suitable (resource-intensive)	Not applicable	Suitable (ecosystem models)
<b>Activity/land-based report</b>					
Forest, grassland, cropland, other land uses	Suitable, if data are available	Suitable, if data are available	Suitable (resource-intensive)	Suitable, particularly to identify land cover/land use and their changes	Suitable, Data-intensive, Can be an alternative approach when estimates from direct measurements and remote sensing are not available
Afforestation, Reforestation, Deforestation, projects	Suitable, if data are available	Suitable, if data are available	Suitable (resource-intensive)	Suitable, particularly to identify land cover/land use and their changes	Not practical

## Bibliography

International Standardization Organization (2005) ISO9000:2005

IPCC (2006) 2006 IPCC Guidelines for National Greenhouse Gas Inventories

IPCC (2003) Good practice guidance for land use, land-use change and forestry. IGES

<http://www.ipcc-nggip.iges.or.jp/public/gpglulucf/gpglulucf.htm>

# 5

## Chapter 5 Monitoring by the stock change method

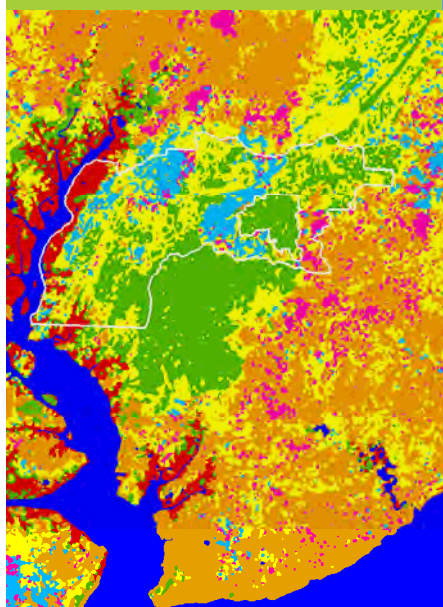



The stock change method involves measuring forest carbon stocks at two different time points and then determining the difference. The stock change method requires two estimations: forest area estimation and carbon stock estimation per unit area of forest. Area estimation is achieved by applying remote sensing technologies. Carbon stock per unit area can be estimated by the permanent sample plot (PSP) method or by using a stand carbon stock estimation model. In this chapter, general introductions of the stock change method, area estimation and estimation of carbon stocks per unit area are followed by more detailed explanations of the PSP method and some stand carbon are introduced. Then the calculation of carbon stocks and changes due to emissions and removals and their uncertainties is described, finally, the establishment of reference levels and reference emission levels on the basis of historical trends in emissions and removals is discussed.

- P07 Stock change method
- P08 Area estimation using remote sensing
- P09 Estimation of carbon stocks per unit area
- P10 Permanent sample plot method
- P11 Using a stand carbon stock estimation model
- P12 Calculation of carbon emissions and removals
- P13 Reference emission level and reference level

## Stock change method

The preceding Recipe is

Recipe P04 Measurement of forest carbon

In the stock change method, as the name suggests, the amount of emissions and removals is determined from the change in the carbon stock at different time points. This method is robust and transparent and can be applied extensively. In this recipe, "forest area" and "carbon stocks per unit area," parameters that are used by the stock change method, are defined and explained.

### INFO

1) IPCC (2006) Chapter 2: Generic Methodologies Applicable to Multiple Land-Use Categories. In: 2006 IPCC Guidelines for National Greenhouse Gas Inventories Volume 4, Agriculture, Forestry and Other Land Use

### INFO

2) UNFCCC (2009) Reducing emissions from deforestation in developing countries: approaches to stimulate action. FCCC/SBSTA/2009/L.19/Add.1

### INFO

3) In addition to forest land, other categories include cropland, grassland, wetlands, settlements, and other.

### INFO

4) IPCC (2006) Chapter 3: Consistent Representation of Lands. In: 2006 IPCC Guidelines for National Greenhouse Gas Inventories Volume 4, Agriculture, Forestry and Other Land Use

## What is the stock change method?

In the 2006 IPCC guidelines, two methods of calculating changes in carbon stocks (forest biomass) are presented: the gain-loss method and the stock change method <sup>1)</sup>. The gain-loss method calculates carbon stock changes by taking the difference between increases and decreases in emissions, as described in P04, whereas in the stock change method the change in carbon stocks (which reflect emissions and removals) is determined from the difference in carbon stocks measured at different time points.

The gain-loss method requires accurate data on carbon stocks lost by logging and forest disturbances, which is often hard to obtain. For this reason, the stock change method, in which the difference in carbon stocks at two different time points is presumed to equal the emissions and removals during that time interval is more widely applicable.

At the national level, remote sensing and ground-based inventory used in combination can effectively determine carbon stock changes <sup>2)</sup>. In the following subsections, estimation of the forest area from remote sensing data and estimation of carbon stocks per unit area by ground-based inventory methods are explained.

## Area estimation (see P08)

To estimate the amount of carbon stock in a forest, the area of the forest must be known. Forest is one land-use category <sup>3)</sup>, but forest land is often converted to another land use, land in another category may be converted to forest by reforestation. The categories and subcategories can be stratified by climate, soil, ecological zone, and management system <sup>4)</sup>.

Three approaches, which differ in how they deal with conversions between land-use categories, are used to represent areas of land-use categories <sup>4)</sup>.

- Approach 1: Total land-use area, no data on conversions between land-uses

- Approach 2: Total land-use area, including changes between categories
- Approach 3: Spatially explicit land-use conversion data

In Approach 1, the total areas of all domestic land-use categories are determined, but conversions between the categories are not considered. Conversions between the categories are tracked in Approach 2, and in Approach 3 these conversions are tracked systematically using detailed spatial information <sup>5)</sup>. In practice, two or three of these approaches may be used in combination.

Regardless of which of these approaches is used, a method must be selected for collecting land-use data. Specific data regarding land-use can be obtained from three sources <sup>4)</sup>.

- Databases prepared for other purposes
- Sampling
- Complete land inventory

Thus, the first source is existing information (maps and statistical information) <sup>6)</sup>. Second, if the existing data are not sufficient, new data can be collected by sampling. The sampling design can use stratification based on auxiliary data and systematic sampling <sup>7)</sup>. Third, a complete inventory can be performed periodically to develop land-use maps of the whole country. Remote sensing technologies make the acquisition of such mapping information over a wide area feasible <sup>8)</sup>.

## Estimation of forest area change

Changes in the forested area can be detected by comparing forest areas estimated by remote sensing at two different time points by one of the following two methods <sup>9)</sup>:

- Post-classification change detection
- Pre-classification change detection

Post-classification change detection means that land covers of remote sensing images acquired at two different times are separately classified, and then the classification results are compared. Pre-classification change detection means using the old and new images together to detect land-cover changes. The results obtained by these two methods can differ; therefore, to in order to select the more appropriate method, it is necessary to understand

### INFO

5) In Approach 3, to obtain more spatially explicit information, the targeted region is divided into grid cells or small polygons. methods are outlined in IPCC GPG Volume 4, Chapter 3, Annex 3A.4. <sup>4)</sup>

### INFO

6) At the national level, information on land use available in national and international databases should be reviewed in advance. One international database is listed in IPCC GPG Volume 4, Chapter 3; however, differences in the definitions and resolution of land-use categories should be taken into account when using it.

### INFO

7) This sampling method is outlined in IPCC GPG Volume 4, Chapter 3, Annex 3A.3. <sup>4)</sup>

### INFO

8) Ground-based inventory is required to verify classification results obtained by using remote sensing data.

### INFO

9) Singh A (1989) Digital change detection techniques using remotely sensed data. Int J Rem Sens 10: 989-1003

their differences (see T11).

### Estimation of the carbon stocks per unit area (see P09)

Carbon stocks per unit area can be estimated in two basic ways: the first is to use permanent sample plots (PSPs) and the second involves the use of a stand carbon stock estimation model <sup>10)</sup>. Here, five methods are outlined, including four methods based on indirect estimation models.

#### INFO

10) Kiyono Y, Saito S, Takahashi T, Toriyama J, Awaya Y, Asai H, Furuya N, Ochiai Y, Inoue Y, Sato T, Sophal C, Sam P Tith B, Ito R, Siregar C.A, Matsumoto M (2011) Practicalities of non-destructive methodologies in monitoring anthropogenic greenhouse gas emissions from tropical forests under the influence of human intervention. *JARQ* 45(2): 233-242

- Permanent sample plots
- Overstory height model
- Crown diameter model
- Community age model
- Backscattering coefficient (Synthetic Aperture Radar)

Each method has advantages and disadvantages and are applicable under different conditions. A ground-based inventory using permanent sample plots has the advantage that it can be used to detect land-use changes, such as conversion to farmland and selective logging, and to monitor forest carbon stocks in a large area over time. For national level measurement, however, many permanent sample plots are needed <sup>11), 12)</sup> (see P10).

#### INFO

11) Fox JC, Yosi CK, Nimiago P, Oavika F, Pokana JN, Lavong K, Keenan RJ (2010) Assessment of aboveground carbon in primary and selectively harvested tropical forest in Papua New Guinea. *Biotropica* 42(4): 410-419

### Estimation of carbon stock change (see P12)

The change in carbon stocks is calculated with the following formula (stock change method):

$$\Delta C = \frac{C_{t_2} - C_{t_1}}{t_2 - t_1} \quad (P07-1)$$

$\Delta C$  = annual carbon stock change in the pool, (t-C/yr)

$C_{t_1}$  = carbon stock in the pool at time  $t_1$  (t-C)

$C_{t_2}$  = carbon stock in the pool at time  $t_2$  (t-C)

This simple formula does not take forest stratification into consideration. In practice, the amount of carbon stocks at each point of time is calculated by classifying (i.e., stratifying) the forest in the target region (national or sub-national level) according to climate regime, forest type, and land management practices. Then, the area and carbon stock per unit area and their product (carbon stocks) are determined for each stratum and the results are summed. Thus, the change in carbon stocks is determined as follows:

#### INFO

12) Samreth V, Chheng K, Monda Y, Kiyono Y, Toriyama J, Saito S, Saito H, Ito E (2012) Tree biomass carbon stock estimation using permanent sampling plot data in different types of seasonal forest in Cambodia. *JARQ* 46(2): 187-192

$$\Delta C = \sum_{ijk} \left[ \frac{C_{t_2} - C_{t_1}}{t_2 - t_1} \right]_{ijk} \quad (\text{P07-2})$$

where index  $i$ ,  $j$  and  $k$  represent climate, forest, and management types.

When estimating carbon stocks, the uncertainty must also be evaluated reduced as much as possible. When estimating the area change from satellite imagery, different definitions and deficiencies in sampling design at the time of the measurements introduce uncertainty <sup>4</sup>). When PSPs are used for estimating carbon stocks, the uncertainty depends largely on how many plots are established and where they are established.

### **Bibliography**

- Köhl M, Magnussen SS, Marchetti M (2006) Sampling Methods, Remote Sensing and GIS Multiresource Forest Inventory. Springer-Verlag
- Ravindranath NH, Ostwald M (2008) Carbon Inventory Methods: Handbook for Greenhouse Gas Inventory, Carbon Mitigation and Roundwood Production Projects. Springer-Verlag

## Area estimation using remote sensing

The preceding Recipe is  
Recipe P07 Stock change method

Estimation of areas of land covers and/or forest types by remote sensing consists of a series of processing and analyses, starting from the selection of appropriate data to summarizing the results. In this recipe, the following remote sensing topics are explained: data types, software, pre-processing, the definition of classes, classification methods, ground truth data, assessment of classification accuracy, and methods of area estimation.

### Types of remotely sensed data and software (see T05)

Optical sensors are the most common sensors for observing the earth's surface, but other types of sensors, such as the synthetic aperture radar (SAR), which can penetrate clouds, or the light detection and ranging (LiDAR), which can measure the tree and/or canopy height, are also available.

Important attributes of remotely sensed data regardless of types of sensor are spatial and temporal resolutions. Spectral resolution is peculiar to the optical sensors.

Data source(s) should be selected by considering the purpose and methods of the use, the cost and the expected accuracy of the products.

### Data pre-processing (see T06)

Raw remote sensing data may have various distortions. Accordingly, they must be pre-processed before analysis to correct for atmospheric and geometric distortions introduced at the time the data are acquired. Atmospheric correction reduces the impact of atmospheric conditions on the reflective signal, and geometric correction modifies the image to suit the map projection.

In addition, it is often hard to obtain images of the earth's surface that are not at least partly obscured by clouds in tropical rain forest areas. To create cloud-free images, cloudless parts are extracted from the acquired images and processed into a mosaic image. This procedure requires corrections for differences in solar radiance. Furthermore, to create a forest distribution map at the national level, the images used to construct the mosaic image are likely to have been acquired at different times of the year. In areas where the forest undergoes seasonal changes, processing to reduce the influence of these seasonal differences, differences in the timing of leaf fall, may be performed. These procedures can be considered pre-processing in the broad sense.

## Definition of classes (see T07)

Land cover and forest type classes of a country should be defined to reflect the forest management regime, ecological characteristics and difference of biomass, and they must be mutually exclusive to each other and collectively exhaustive, without any overlap with other classes. When remote sensing data are used for the classification the definitions of the classes must take into account the accuracy and resolution of the remote sensing data, and at the same time they must not contradict existing forest classification criteria.

## Ground truth (see T08)

Field survey data on land covers, forest types, and forest biomass collected for the purpose aiding in the analysis of remote sensing data is called ground truths (Figure P08-1). These data can be used as training data in the classification process or as verification data for evaluating the results of the classification. Ground truths can be collected by random sampling or by stratified sampling. Stratified sampling is often preferable when funds or human resources are limited. Another consideration is the possibility of limited access to some parts of the forest, which can lead to biases if fewer samples are collected in less accessible places.



Figure P08-1 Confirmation of geographic coordinates in ground truthing

## Classification methods (see T09)

Classification is a process by which data are divided by statistical methods according to their features. Classification processing can be "unsupervised" or "supervised." In unsupervised classification, the data are classified by

clustering using only statistical features of the spectral information of remote sensing data. Each cluster is labeled by comparison with ground truths. In supervised classification, spectral features are extracted from the remote sensing data by using ground truths as training data, and statistical methods are used to assign the remotely sensed data to a class.

Classification of remote sensing data can be either pixel-based or object-based. In pixel-based classification, each pixel of a remote sensing image is classified using the spectral feature of each wavelength band. In object-based classification, a remote sensing image is divided into objects by using information on color and shape, and the objects are classified by using the spectral information and texture information within each object. In object-based classification, a computer draws the boundary lines between objects, and a result similar to a visually interpreted image can be efficiently obtained (Figure P08-2).

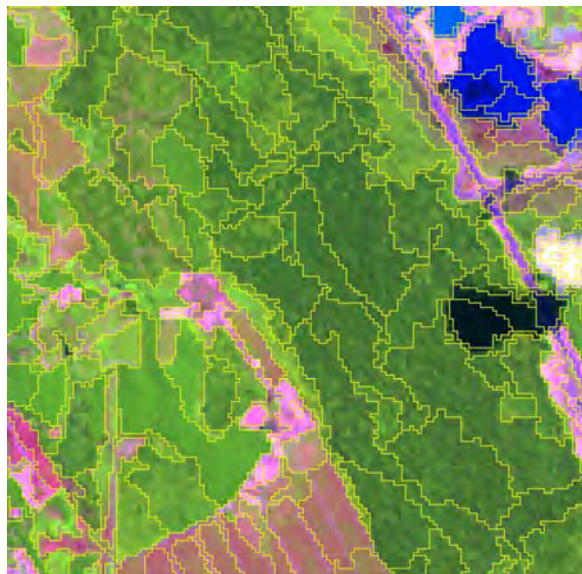

Figure P08-2 Object-based classification of Landsat imagery

### Verifying the accuracy of classification results (see T10)

The validity of the classification results must be verified. This is accomplished by creating an error matrix from verification data obtained by ground truths. Overall accuracy, user's accuracy, producer's accuracy, and the kappa coefficient are often used as indices of accuracy. About 50 samples, at least, are required per class for accuracy verification. The area biases are evaluated and corrected by using an error matrix.



## Estimation of forest area change (see T11)

As described in P07, forest area change can be delineated either by comparing classified images (post-classification method) or by comparing images before classification (pre-classification method). In post-classification, the classification of each image is performed independently then changes are identified at where the assigned classes of the two time period are not identical. Pseudo-changes due to inaccurate image registration or ambiguous class boundaries should be corrected. Pre-classification, and thus it requires the next step to understand and assign from which to which classes they occurred.

### Bibliography

- Lillesand TM, Kiefer RW, Chipman JW (2007) Remote Sensing and Image Interpretation, sixth edition. Wiley
- McCoy RM (2005) Field Methods in Remote Sensing. Guilford Press
- Alexander R, Millington AC (2000) Vegetation Mapping. Wiley

## Estimation of carbon stocks per unit area

The preceding Recipe is  
Recipe P07 Stock change method

For Tier 2 and Tier 3 measurements, information on carbon stocks must be collected periodically at the national level. When the stock change method is used to estimate changes in carbon stocks over time, the parameter "carbon stocks per unit area" can be estimated by measuring permanent sample plots, or stand carbon stock estimation models can be used. In this recipe, each of these two estimation methods is outlined.

### INFO

1) The estimated result is expressed as forest biomass (t/ha) and it must be converted to forest carbon stocks (t-C/ha) by multiplying the forest biomass value by the carbon content factor (0.5).

### Attainable resources (see T03)

The estimation of the amount of carbon stocks per unit area <sup>1)</sup> is done by two methods: a method that directly measures the amount of carbon in the forest, and a method that indirectly measures the amount of carbon stocks using the estimation model. The selection of locations to be surveyed, the number of points to be surveyed, and the skill level of individuals conducting the survey and analysis affect the estimation regardless of which method is used. Here, for simplicity, useful information and techniques for accurate estimation of carbon stocks are called "resources".

Some countries have already conducted forest and soil surveys as a part of a national forest inventory or local projects. Information from such surveys can be an important resource for the estimation of carbon stocks. For instance, information on land use and forest types, which is necessary for application of the stock change method, can be obtained from existing information on soil and vegetation patterns and climatic zones. Data on tree diameters and tree species obtained for timber production are also resources that can be used for estimating forest carbon stocks per unit area. Information about deforestation and forest degradation, which is used for simulations of forest area trends, can also be used to help select locations for permanent sample plots (PSPs) or in the design of temporary sampling schemes for stand carbon stock estimation models. In addition, project teams that have managed past forest surveys can help establish a task force for REDD activities.

Each of the various survey methods that have been proposed has advantages and disadvantages (Table P09-1). The selected methodology should take into account resources available in the project area.

### Direct measurement of carbon stocks (permanent sample plot method) (see P10)

To directly measure carbon stocks, permanent sample plots are established in the forest, and the species of trees that grow in those plots, along with the sizes of individual trees and the populations of trees are determined. Establishing permanent sample plots and conducting the necessary measurements are labor-intensive activities that are feasible only in areas that are accessible to the

individuals conducting the survey. However, both the methods and tools used for this type of survey are simple and the acquired data are highly accurate.

### Indirect measurement of carbon stocks (stand estimation model method) (see P11)

There are a suit of methods indirectly estimating carbon stocks. They are useful especially when ground-based survey alone is difficult due to accessibility on the ground. Indirect methods often involves a trade-off between the cost of equipment needed and the accuracy of the analysis. Carbon stock can be estimated by the stand age in the case of homogeneous stands where the number of individuals per unit area is already known and where species, stand age, and tree size are uniform, such as timber plantations. In other cases, remotely measurable stand parameters, such as overstory height, crown diameter, community age, or backscattering coefficient (SAR data), can be used in such indirect models. There are choices of remotely sensed data, such as satellite imagery or aerial photograph, depending on the circumstances of country and/or area.

### Bibliography

Kiyono Y, Saito S, Takahashi T, Toriyama J, Awaya Y, Asai H, Furuya N, Ochiai Y, Inoue Y, Sato T, Sophal C, Sam P Tith B, Ito R, Siregar CA, Matsumoto M (2011) Practicalities of non-destructive methodologies in monitoring anthropogenic greenhouse gas emissions from tropical forests under the influence of human

Table P09-1 Matrix of choices of methods for estimating anthropogenic greenhouse gas emissions from forests under various forms of human intervention (after Kiyono et al., 2011)

Approaches	Requirements	Costs	Getting data in a large land area	Technical difficulties	Applicability of the method in estimating anthropogenic GHG				Improvement in accuracy expected by local people participating in the monitoring
					Conversion to crop land	Reducing fallow period of slash-and-burn agriculture	Logging	Fuel wood collection	
PSP data	Measurement on the ground	High	Difficult	Limitation in representativeness and <u>secretness of plot.</u>	Possible	Possible	Possible	Possible	High
Community age	Remote sensor with medium or higher resolution	Medium	Easy	Applicable to land use with periodical naked land stages e.g. slash-and-burn farming.	Impossible	Possible	Impossible	Impossible	Low
Crown diameter	Remote sensor with high resolution Aerial photograph	High	Medium	Not applicable when clouded. Crowns are hardly recognized in <u>some forests.</u>	Partly possible	Impossible	Partly possible	Impossible	Low
Overstory height	Multi-polarization SAR	Low	Medium	Methods are not tested. Applicable to small parts of globe.	?	?	?	Impossible	Low
	Airborne LiDAR	High	Difficult	Nothing in particular.	Possible	Possible	Possible	Impossible	Low
	Stereo mapping remote sensor (DSM)	Medium	Easy	Not applicable when clouded. Methods are not tested.	?	?	?	Impossible	Low
Backscattering coefficients	Measurement on the ground	?	Difficult	Methods are not tested. Applicable to small parts of globe.	Possible	Possible	Possible	Impossible	High
	SAR with microwaves longer than L-band	Low	Medium	Not applicable to areas with steep slopes. Not applicable to high biomass forest.	Partly possible	Partly possible	Impossible	Impossible	Low

This table is applicable to dry land forest.

## Permanent sample plot method

The preceding Recipe is

Recipe P09 Estimation of carbon stocks per unit area

A ground inventory site is called a permanent sample plot when tree diameter at breast height (DBH) and tree heights are measured every several years to track forest changes. In this recipe, the number of plots and their locations required by the selected survey method, other things to be considered in the design and measurement of permanent sample plots, and methods of estimating carbon stocks from permanent sample plot data are explained.

### Required number of permanent sample plots and their locations (see T12)

To estimate carbon stocks efficiently in a large area (national or sub-national level), the number and locations of permanent sample plots must be appropriately chosen according to the sampling survey method used. When the population is large enough, the required number of permanent sample plots ( $n$ ) can be obtained with the following formula <sup>1)</sup>.

$$n \geq \left( \frac{t \cdot CV}{E} \right)^2 \quad (\text{P10-1})$$

where  $E$  is the allowable error rate (half the width of the confidence interval divided by the average value of carbon stock),  $CV$  is the coefficient of variation, and  $t$  is the  $t$  statistic for a significance level of the  $t$ -distribution of 5% with  $(n - 1)$  degrees of freedom. Thus, as  $E$  becomes smaller or  $CV$  increases, the required number of permanent sample plots ( $n$ ) increases. For example, for the national forest inventory carried out in Japan in 1961,  $n$  was calculated for  $E = 3\%$ ,  $t = 2$ , and  $CV = 150\%$  as follows:

$$n \geq \left( \frac{2 \times 1.5}{0.03} \right)^2 = 10000 \quad (\text{P10-2})$$

Therefore, the required number of plots was 10,000. To determine an appropriate  $CV$ , prior information about the whole forest or each forest type is required. Its selection should be based on the results of a pilot survey or past experience.

To prevent permanent sample plots from being concentrated in readily accessible locations such as near roads or villages, permanent sample plots should be established by using either a simple random sampling method <sup>2)</sup> or a systematic sampling method <sup>2)</sup>. Moreover, a stratified sampling method <sup>2)</sup>, in which the number of sampling sites and their locations by forest categories is decided in advance on the basis of remote sensing data, can improve sampling survey efficiency.

#### INFO

1) Fox JC, Yosi CK, Nimiago P, Oavika F, Pokana JN, Lavong K, Keenan RJ (2010) Assessment of aboveground carbon in primary and selectively harvested tropical forest in Papua New Guinea. *Biotropica* 42(4): 410-419

#### INFO

2) Gibbs KH, Brown S, Niles OJ, Foley AJ (2007) Monitoring and estimating tropical forest carbon stocks: making REDD a reality. *Environ Res Lett* 2: 045023

## Design and measurement of permanent sample plots (see T13)

Permanent sample plots should be designed to enhance field measurement efficiency. Generally, permanent sample plots are circular or square. In many cases, one plot consists of nested compartments of different sizes <sup>3)</sup>. For example, in Japan permanent sample plots are arranged in a 4-km mesh and each consists of three concentric circles with radii of 5.64, 11.28, and 17.84 m, in which the minimum diameter of the measurement target (a standing tree) is 1, 5, and 18 cm, respectively <sup>4)</sup>.

Since measurements are carried out every several years, it is imperative to install signs at the entrance to the plots and along plot boundaries (Figure P10-2), to attach an aluminum tag with the tree number to each measured tree, and to mark breast height on each tree <sup>5)</sup>. Moreover, because the tree number tags often fall off, a map showing the positions of all standing trees is needed. Furthermore, to minimize measurement error, a detailed measurement manual and prior measurement exercises conducted by experts are required <sup>4)</sup>, <sup>5)</sup>.

## Analysis of permanent sample plot data (see T14)

The carbon stock represented by standing trees is calculated as one half the tree biomass <sup>3)</sup>. Biomass can be estimated from the permanent sample plot measurement data <sup>6)</sup> by using an allometric equation that relates biomass, including branches and leaves, of a tree to the tree's DBH or to both tree DBH and tree height. Allometric equations have been created for the various regions and tree species (or groups of species). For trees in the tropics, equations developed by Brown <sup>7)</sup> and Chave and colleagues <sup>8)</sup> are often used.

Biomass can also be estimated by using biomass expansion factors (BEFs) <sup>6)</sup>. A biomass expansion factor is a coefficient that relates dry volume ( $\text{m}^3$ ), which has been obtained since ancient times by general forest inventory methods, to biomass, including branches and leaves. It is denoted by the ratio of the biomass to the dry volume ( $\text{Mg}/\text{m}^3$ ). biomass expansion factors have also been determined for various areas and species (or groups of species).

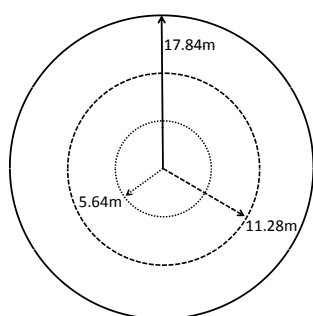

Figure P10-1 Plot shape used in the Japanese NFI. Plots are arranged in a grid with a 4-km grid interval



Figure P10-2 Signpost for a plot in Cambodia

### INFO

3) Pearson T, Walker S, Brown S (2005) Sourcebook for land use, land-use change and forestry projects. Winrock International and the BioCarbon Fund of the World Bank

### INFO

4) Kitahara F, Mizoue N, Yoshida S (2009) Evaluation of data quality in Japanese National Forest Inventory. *Environ Monit Assess* 159: 331-340

### INFO

5) Kitahara F, Mizoue N, Yoshida S (2010) Effects of training for inexperienced surveyors on data quality of tree diameter and height measurements. *Silva Fennica* 44: 657-667

### INFO

6) Brown S (2002) Measuring carbon in forests: current status and future challenges. *Environ Pollut* 116: 363-372

### INFO

7) Brown S (1997) Estimating biomass and biomass change of tropical forests: a primer. *FAO Forestry Paper* 134. FAO

### INFO

8) Chave J, Andalo C, Brown S, Cairns MA, Chambers JQ, Eamus D, Fölster H, Fromard F, Higuchi N, Kira T, Lescure J-P, Nelson BW, Ogawa H, Puig H, Riééa B, Yamakura T (2005) Tree allometry and improved estimation of carbon stocks and balance in tropical forests. *Oecologia* 145: 87-99

## Using a stand carbon stock estimation model

The preceding Recipe is

Recipe P09 Estimation of carbon stocks per unit area

In addition to the permanent sample plot method (P10), carbon stocks per unit area can be estimated by using a stand carbon stock estimation model. Several models with different parameterizations and thus different approaches to the estimation of carbon stocks have been proposed. In this recipe, the assumption of using a stand carbon stock estimation model and the characteristics of different models, based on overstorey height, crown diameter, community age, and backscattering coefficient (SAR), are also explained.

### INFO

1) The models discussed here mainly estimate the carbon stocks of above-ground and below-ground biomass. Not all these methods are suitable for estimating the sizes of other carbon pools, such as the dead wood and litter. Therefore, to estimate stocks in these other carbon pools, a field survey is also necessary.

### INFO

2) Mascaro J, Asner GP, Muller-Landau HC, Breugel Mv, Hall J, Dahlin K (2011) Controls over aboveground forest carbon density on Barro Colorado Island, Panama. *Biogeosciences* 8: 1615-1629

### INFO

3) Saatchi SS, Harris NL, Brown S, Lefsky M, Mitchard ETA, Salas W, Zutta BR, Buermann W, Lewis SL, Hagen S, Petrova S, White L, Silman M, Morel A (2011) Benchmark map of forest carbon stocks in tropical regions across three continents. *PNAS* 108: 9899-9904

## Establishment and verification of the model

With the permanent sample plot method (see P10 and Chapter 8), deforestation and forest degradation due to land-use changes (e.g., conversion to farmland or disturbance by selective logging) are easy to detect, and because it can be used regardless of forest or vegetation type, it is very flexible. However, REDD-plus requires high-accurate data, which means that a large number of plots must be established, which inevitably increases the time and effort and expense of the method. Therefore, a technique for indirect estimation of carbon stocks per unit area that uses a relational equation to relate carbon stocks to some parameter whose value can be obtained without a field survey can be an effective choice. However, model estimates must have their accuracy verified by a field survey to fulfill the measurement, reporting, and verification (MRV) requirements of REDD-plus. To attain the target level of accuracy, the field survey design and model selection must take into consideration the cost of data acquisition and the number of samples needed for the model (see T15).

In the following sections, stand carbon stock estimation models with different stand parameters, i.e. overstorey height, crown diameter, community age, or the backscattering coefficient, are outlined <sup>1)</sup>.

## Overstorey height method (see T16)

The overstorey height method estimates carbon stocks per unit area by assuming that overstorey height is directly proportional to biomass <sup>2), 3)</sup>. Information on overstorey height is acquired from ground-based inventory or by remote sensing (airborne LiDAR, polarimetric interferometry SAR, or satellite-borne stereoscopic sensors). The cost of implementation and the size of the measurement area vary widely and depend on the sensor used. According to the precedent studies, the relationship between overstorey height and biomass is often stable. Also, significant differences are not observed among different forest types of an area in the relationship between overstorey height and biomass. Tree height data from tree census studies are needed for creating the relational equation, and its measurement accuracy and the number of samples are also important.

## Crown diameter method (see T17)

The crown diameter method estimates carbon stocks per unit area by assuming that individual tree biomass increases exponentially with the diameter of the tree crown <sup>4</sup>). Information on tree crown diameters is obtained by using aerial photos or high-resolution satellite imagery. The implementation cost is high, and the optical sensor used is affected by clouds, but forest degradation caused by selective logging of large-diameter trees can be detected and quantified. Because the method depends on the visibility of the tree crown, it is suitable for forests with large-diameter trees or open forests, but not for young secondary forests or bamboo forests. Moreover, satellite imagery yields information on the tree crown diameters of upper story trees only; the biomass of understory trees must be separately estimated.

## Community age method (see T18)

The community age method estimates carbon stocks per unit area by the community age assuming that the community biomass increases monotonically as the community age <sup>5</sup>). Temporal and spatial distribution of community ages can be estimated by detecting the emergence of denuded lands using a time series of remotely sensed images with medium to high resolution sensors (see T05). Since denuded land is assumed as the origin of community age, failure to detect bare land by the time-series imagery directly reduces the accuracy of the method; thus, monitoring at least once a year is required. The cost of the method is moderate. It is most effective for land-use systems in which the land is denuded to reestablish the community, such as slash-and-burn agriculture and rubber plantations. In such land-uses, frequency of denuding is most relevant to the average stand carbon stocks through time.

## Backscattering coefficient method (see T19)

The backscattering coefficient method estimates above-ground biomass per unit area from the backscattering coefficient ( $\sigma^0$ , units dB) obtained by SAR. The backscattering coefficient increases monotonically with the above-ground biomass, allowing a saturation curve for above-ground biomass to be drawn. For the estimation of stands with moderate or high stocks, the relationship must be determined empirically, because the simple estimation equation is difficult <sup>6</sup>). SAR microwave radiation passes through clouds; therefore, the method is particularly useful in regions with year-round cloud cover <sup>7</sup>). Long-wavelength microwaves are advantageous for forests. Implementation costs are small, and it is easy to compare multiple scenes and is excellent for estimations of biomass in large areas. On the other hand, analysis is not easy because stand structure, topography, soil moisture, land-surface conditions, and multiple reflections affect the analysis result, and there are a number of technical issues that must be overcome.

### INFO

4) Kiyono Y, Saito S, Takahashi T, Toriyama J, Awaya Y, Asai H, Furuya N, Ochiai Y, Inoue Y, Sato T, Sophal C, Sam P, Tith B, Ito E, Siregar CA, Matsumoto M (2011) Practicalities of non-destructive methodologies in monitoring anthropogenic greenhouse gas emissions from tropical forests under the influence of human intervention. *JARQ* 45: 233-242

### INFO

5) Inoue Y, Kiyono Y, Asai H, Ochiai Y, Qi J, Olioso A, Shiraiwa T, Horie T, Saito K, Dounagsavanh L (2010) Assessing land-use and carbon stock in slash-and-burn ecosystems in tropical mountain of Laos based on time-series satellite images. *Int J Appl Earth Obs Geoinf* 12(4): 287-297

### INFO

6) Carreiras J, Vasconcelos MJ, Lucas RM (2012) Understanding the relationship between aboveground biomass and ALOS PALSAR data in the forests of Guinea-Bissau (West Africa). *Remote Sens Environ* 121: 426-442

### INFO

7) Ju J, Roy DP (2008) The availability of cloud-free Landsat ETM+ data over the conterminous United States and globally. *Rem Sens Environ* 112: 1196-1211

## Calculation of carbon emissions and removals

The preceding Recipe is

Recipe P07 Stock change method

Recipe P08 Area estimation using remote sensing

Recipe P09 Estimation of carbon stocks per unit area

In this recipe, a method for calculating carbon stocks and their changes (emissions and removals) is explained. To enhance the reliability of the carbon credit system, it is important to reduce the uncertainties of the calculated values <sup>1)</sup>. A method to combine uncertainties <sup>2)</sup> with calculation examples based on sample data is explained here.

### INFO

1) The uncertainty of the average value calculated here is the ratio (%) of the difference between the 95 % confidence interval maximum (or minimum) value and the average value to the average value. If a normal distribution is assumed, then the difference between the 95 % confidence interval maximum and average value  $\mu$  corresponds to 1.96 times the standard deviation, and the uncertainty  $U$  (%) is calculated from the average estimate  $\mu$  and the standard deviation  $\sigma$  with the following formula.

$$U = 100 \times (1.96 \times \sigma) / \mu$$

### INFO

2) Instead of combining uncertainties, the uncertainty can be also evaluated by a Monte Carlo method. In this case, uncertainty is estimated by simulating the statistical distribution of observation using random numbers generated by computer and calculating the 95 % confidence interval of the distribution. With the data of Table P12-1, the values  $\Delta C = -622.5$  t-C/yr, and  $U_{\Delta C} = 30.9$  were obtained by 10,000 iterations.

### Calculation of carbon stocks and carbon stock change

In the stock change method, the carbon stock (t-C) is obtained by multiplying the forest area (ha) by the carbon stock per unit area (t-C/ha). The carbon stocks of the entire project area at a given time are obtained by calculating the products of the carbon stocks per unit area for each forest type and the area occupied by that type and then summing the results over all forest types:

$$C_t = \sum_{i=1}^n (A_i \times C_i) \quad (\text{P12-1})$$

$C_t$  : total carbon stock at a certain time  $t$  (t-C)

$A_i$  : area occupied by forest type  $i$  (ha)

$C_i$  : carbon stock per unit area of type  $i$  (t-C/ha)

Emissions and removals are calculated with equation .

$$\Delta C = \frac{C_{t_2} - C_{t_1}}{t_2 - t_1} \quad (\text{P12-2})$$

$\Delta C$  : net change in carbon due to emissions and removals (t-C/yr)

$C_{t_1}, C_{t_2}$  : total carbon stocks at times  $t_1$  and  $t_2$ , respectively (t-C)

The total carbon stocks and the emissions and removals calculated from forest carbon monitoring data can be used to set the reference level and the reference emission level (see P13).

### Uncertainties of the calculated amounts

The uncertainty of the carbon stocks for each forest type due to measurement errors introduced in determining the area and the carbon stock per unit area is calculated with equation (P12-3):

$$U_i = \sqrt{U_{A_i}^2 + U_{C_i}^2} \quad (\text{P12-3})$$



$U_i$  = Uncertainty of carbon stock of forest type  $i$  (%)

$U_{Ai}$  = Uncertainty of area of forest type  $i$  (%)

$U_{Ci}$  = Uncertainty of carbon stock per unit area of forest type  $i$  (%)

$U_t$  is calculated for all forest types, and the results are used in equation (P12-4).

$$U_t = \sqrt{\sum_{i=1}^n (U_i \times M_i)^2} / \sum_{i=1}^n M_i \quad (\text{P12-4})$$

$U_t$  = Uncertainty of total carbon stock at time  $t$  (%)

$M_i$  = Average carbon stock of forest type  $i$  ( $= A_i \times C_i$ ; t-C)

Finally, the uncertainty of net emissions and removals between times  $t_1$  and  $t_2$  is calculated with equation (P12-5).

$$U_{\Delta C} = \sqrt{(U_{t_2} \times C_{t_2})^2 + (U_{t_1} \times C_{t_1})^2} / |C_{t_2} - C_{t_1}| \quad (\text{P12-5})$$

$U_{\Delta C}$  = Uncertainty of net emissions and removals (%)

In the example below, hypothetical data are used to calculate emissions and removals and the uncertainty. Survey data for an evergreen forest and a deciduous forest are shown in Table P12-1. The net emissions and removals  $\Delta C$  and the uncertainty  $U_{\Delta C}$  is solved as follows by using equations (P12-2) and (P12-5), respectively.

$$\Delta C = (16204 - 22440) / (2010 - 2000) = -623.6$$

$$U_{\Delta C} = \sqrt{(6.5 \times 16204)^2 + (7.2 \times 22440)^2} / |16204 - 22440| = 30.9 \%$$

## Bibliography

GOFC-GOLD (2011) A sourcebook of methods and procedures for monitoring and reporting anthropogenic greenhouse gas emissions and removals caused by deforestation, gains and losses of carbon stocks in forests remaining forests, and forestation: GOFC-GOLD Report version COP17-1. GOFC-GOLD

IPCC (2003) Good practice guidance for land use, land-use change and forestry. IGES

Table P12-1 Example calculation of forest carbon stock and its change (Result of calculations are in italics)

Carbon data	$A_i$	$U_{Ai}$	$C_i$	$U_{Ci}$	$A_i \times C_i$	$\sqrt{U_{Ai}^2 + U_{Ci}^2}$	$C_t$	$U_t$
(unit)	(ha)	(%)	(t-C/ha)	(%)	(t-C)	(%)	(t-C)	(%)
EV in 2000	100	6	150	8	<i>15000</i>	<i>10.0</i>	<i>22440</i>	<i>7.2</i>
DD in 2000	93	4	80	7	<i>7440</i>	<i>8.1</i>		
EV in 2010	88	8	120	9	<i>11560</i>	<i>9.5</i>	<i>16204</i>	<i>6.5</i>
DD in 2010	68	2	83	5	<i>5644</i>	<i>5.4</i>		

EV = evergreen forest, DD = deciduous forest

## Reference emission level and reference level

The preceding Recipe is

Recipe P12 Calculation of carbon emissions and removals

To quantify reductions in emissions achieved by REDD-plus activities, it is first necessary to establish a reference emission level and/or a reference level and to compare them with the actual emissions. In this recipe, reference emission levels and reference levels, as defined in discussions of the meeting of experts held at the request of the Subsidiary Body for Scientific and Technological Advice (SBSTA) under the United Nations Framework Convention on Climate Change (UNFCCC), are explained. In addition, ongoing discussions under the UNFCCC and challenges in establishing reference emission levels and emission levels are described.

### Establishment of reference emission level and reference level

The basic concept of REDD-plus is to provide economic incentives such as funds or credits to developing countries for REDD activities - reducing emissions from deforestation and forest degradation in developing countries - and "plus" activities - preventing CO<sub>2</sub> emissions and reducing CO<sub>2</sub> in the atmosphere by carbon sequestration. To quantify reductions in CO<sub>2</sub> due to REDD-plus activities relative to expected CO<sub>2</sub> levels were REDD-plus activities not undertaken, a reference emission level or a reference level must be established. In a meeting of experts held at the request of SBSTA<sup>1), 2)</sup>, the "reference emission level" and the "reference level" were distinguished in two ways:

1. The "reference emission level" is net emission established by the whole country, and the "reference level" is net absorption.
2. The "reference emission level" is used evaluate activities to reduce emissions resulting from deforestation (REDD activities), and the "reference level" is used to evaluate "plus" activities.

In some cases, both a reference emission level and a reference level will be established in the same country. To enable more REDD-plus activities to be implement stepwise in the National Strategy and Action Plan of developing countries, many experts agreed that flexibility should be allowed in establishing the reference emission level and reference levels.

To establish a reference emission level or a reference level, historical data on deforestation and forest degradation are essential. Deforestation can be identified relatively easily by using historical time-series satellite data because deforestation is a clear land-use change. Data on forest carbon stock changes are indispensable for establishing the reference emission level. Therefore, it is vital to estimate forest carbon stocks before deforestation occurs. On

#### INFO

1) UNFCCC (2009) FCCC/SBSTA/2009/2, UNFCCC

#### INFO

2) UNFCCC (2011) FCCC/SBSTA/2011/INF.18, UNFCCC

the other hand, forest degradation monitoring is more technically difficult. However, degradation that causes a large decrease in forest carbon stocks can in many cases be monitored by remote sensing. Thus, during the SBSTA meeting of experts, some were of the opinion that emissions caused by deforestation should be taken into account when establishing the reference emission level or reference level but that emissions from forest degradation should not necessarily be taken into account. To identify forest degradation, not only remote sensing but also ground-based carbon stock monitoring and measurement are considered to be essential.

## Discussions under UNFCCC

The 15<sup>th</sup> conference of the Parties (COP 15) concluded that when developing countries establish a reference emission level or reference level, they should take account of their nation's circumstances, while ensuring transparency by using their own historical data. COP 16 decided that the forest reference emission level and the forest reference level at the national level, or the sub-national level as a transitional measure, should be established before REDD-plus activities are implemented in developing countries. However, their definitions and details of how to establish them remain unsettled.

At COP 17, the modality of reference emission levels and reference levels were discussed and the Parties came to the following conclusions:

- The reference emission level and the reference level are criteria for evaluating each country's performance in the implementation of REDD-plus activities and should be calculated in terms of CO<sub>2</sub>
- The established reference emission level and reference level should be consistent with the emissions and removals in the forest that are included in national greenhouse gas (GHG) inventories
- To develop a reference emission level or a reference level, better data and improved methods and, if appropriate, a phased approach which incorporates additional carbon pools, is effective
- A preliminary reference emission level or emission level at the sub-national level should be developed during the period of transition to national level reporting.

## Organizational challenges

Historical data are essential for establishing a reference emission level and

reference level. However, the reference emission level or reference level can vary greatly depending on the period of historical data acquisition and the sort of model used. With a more precise model, data should be available at more time points. Therefore, full discussions should be held regarding the selection of a model for estimating future trends and the appropriate time interval for obtaining the historical data required to create the model.

For forest carbon crediting, highly accurate monitoring is required that must be measurable, reportable, and verifiable (MRV). However, the availability of historical data may be limited. Establishing an appropriate reference emission level/reference level in such a way that transparency and reliability are ensured while national circumstances are taken into account is extremely important for the success of REDD-plus. Capacity building in accordance with the national circumstances may be required because the technology and data needed for establishing the reference emission level and/or reference level are possessed to a varying degree by developing countries. Full implementation of REDD-plus in developing countries should take place only after the reference emission level and reference level have been provisionally established during demonstration activities and the organizing challenges have been successfully satisfied.



# Technical

# 6

## Chapter 6 Preparation for REDD-plus implementation



Before REDD-plus can be implemented by a country, the preparation status of that country must be determined. Are forest distribution data available? What information resources and technical expertise does the implementation country have? Which greenhouse gas (GHG) should be measured preferentially there? The readiness state of a candidate country must be understood so that an appropriate carbon stock estimation technique can be chosen according to the resources that are available or can be obtained.

- T01 National forest inventory
- T02 What greenhouse gases are measured?
- T03 Attainable resources
- T04 Voluntary carbon credit certification system

## National forest inventory

The preceding Recipe is

Recipe I03 Measurement, reporting and verification (MRV) of forest monitoring

In many developed countries, a forest resources survey of the entire country, called the national forest inventory (NFI), is periodically carried out to assess the forest resources of that country. Here, statistical sampling design, sampling plot types, and sampling methodology appropriate for a national forest inventory are described.

### What is national forest inventory?

In order to evaluate forest resource of the entire country (e.g. areas volume and increment of growing stock, etc.), a forest resources survey is periodically carried out by the unified technique in most European and North American countries. This is called the national forest inventory. Today, sample-based national forest inventory data can be used for accurate carbon absorption by the forest.

### National forest inventory sampling designs

For statistical sampling, a map grid with a grid interval of 0.5–20 km is typically used, and sampling plots or groups of plots (plot clusters) are established at grid points or at reference points whose position is fixed by a certain rule (Figure T01-1). Because some plot locations may not be in the forest area, it is also possible to use, for example, aerial photographs or field observations to estimate the total forest area by ascertaining whether or not plots are in the forest.

The use of plots of different shapes or of plot clusters reflects differences in the forest environment of each country. In many countries, circular plots are used, but plots in the natural forests of China, Brazil, and New Zealand are

rectangular. In some countries (e.g., France), circular plots consisting of two, three, or four concentric circles are used.

In western Europe (e.g., France) and Japan, a single-plot system is typical (Figure T01-2). In central Europe (e.g., Germany), small clusters consisting of four plots about 150–500 m apart and arranged in a square are used,

whereas in northern Europe, large

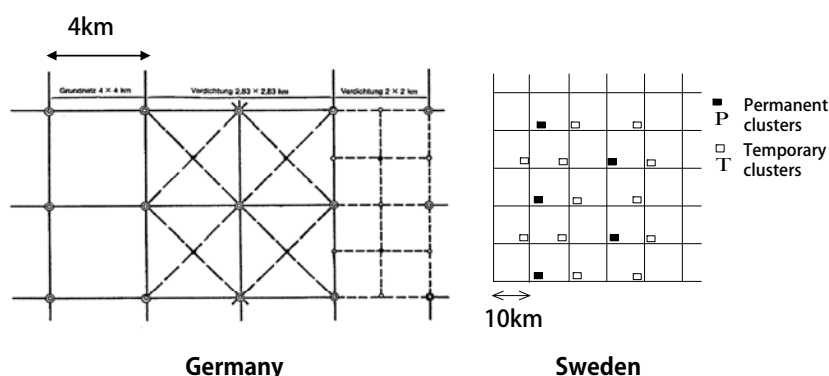

Figure T01-1 Examples of grid for systematic samplings in national forest inventory



clusters that may consist of 10 plots or more arranged in a rectangle, each side of which is more than 1000 m long, are used. Moreover, in Brazil, a cross-shaped cluster is used, and in the United States, a cluster consists of three plots arranged in an equilateral triangle with a fourth plot at the center of the triangle.

The advantage of using plot clusters is that it is possible to collect many data from several plots within a short time period, because the plots are close together. On the other hand, because plots in the same cluster may not be statistically independent, the statistical analysis is more complicated.

## Conducting the inventory

Forest carbon stocks are estimated by conducting a census of the trees in the sampling plots. For single circular plots consisting of concentric circles, standing trees with small diameter are measured in the innermost circle. For example, in France, each circular plot consists of three concentric circles with radii of 6, 9, and 15 m, and standing trees with a diameter at breast height (DBH) of 7, 20, or 37 cm are measured in the innermost, the middle, and the outermost circle, respectively. Since tree height measurement requires considerable time and effort, only some standing trees are usually chosen for this measurement. To measure parameters such as biodiversity, measurements and other information of understory vegetation, fallen trees, tree stumps, soil, etc., are also collected and recorded.

## National forest inventories in tropical countries

In tropical countries, because of difficulties of access and technical problems, national forest inventories similar to those conducted in Western countries may be hard to carry out. Brazil, however, first performed a national forest inventory in 2005<sup>1)</sup>. There, a map grid with a grid interval of about 20 km interval has been established, and four 20 m × 50 m plots are arranged in a cross shape centered at each grid point. Standing trees with a DBH of 10 cm or more are measured. Subplots of 10 m × 10 m have been established within each plot for measurement of smaller diameter trees, and seedlings are censused in a 5 m × 5 m subplot within each plot.

### INFO

1) Tomppo E, Gschwantner M, Lawrence M, McRoberts RE (2010) National Forest Inventories. Springer-Verlag

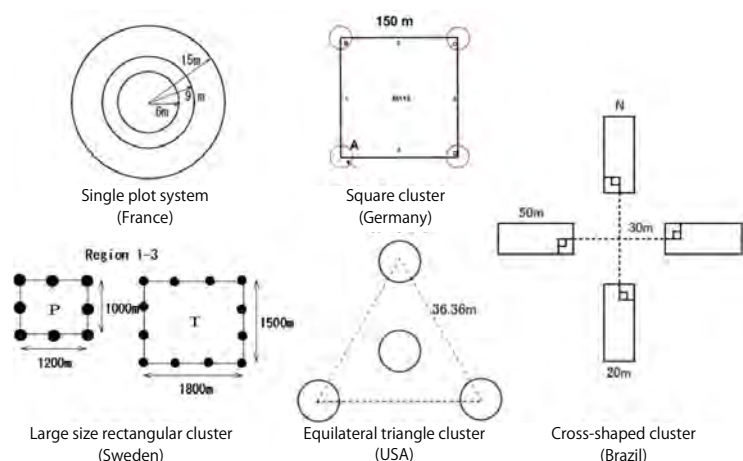

Figure T01-2 Type classification of the national forest inventory plot

## What greenhouse gas are measured?

The preceding Recipe is

Recipe P04 Measurement of forest carbon

To monitor greenhouse gas (GHG) emissions efficiently, it is important to clarify the measurement target. In this recipe, possible REDD-plus measurement targets, the greenhouse gases carbon dioxide, methane, and nitrous oxide, and five carbon pools in a forest, above-ground biomass, below-ground biomass, dead wood, litter, and soil organic matter, are described.

### INFO

1) As one judgment criterion, if a greenhouse gas source accounts for more than 25% of total emissions in preliminary calculations, that source should be measured. Furthermore, the sum of the contributions from all measured sources should be more than 95% of total emissions. A high-priority source that is a target of monitoring is called a key category.

### INFO

2) Kiyono Y, Saito S, Takahashi T, Hirai K, Saito H, Toriyama J, Monda Y, Awaya Y, Shimada M, Inoue T, Hatano R, Sophal C, Samreth V, Sum T, Kanzaki M, Limin SH, Jaya INS (2011) Important subcategory of greenhouse gas emissions from degraded forestland: CO<sub>2</sub> emissions from biomass in a seasonal forest in Cambodia and soil organic matter in a peat swamp forest in Indonesia. The Kanto Forest Research 62: 167-170

### Which greenhouse gases should be the target of REDD-plus activities

In REDD-plus, three greenhouse gases, CO<sub>2</sub> (carbon dioxide), CH<sub>4</sub> (methane), and N<sub>2</sub>O (nitrous oxide), are the most usual monitoring targets. Regardless of the forest ecosystem type, measurement of CO<sub>2</sub> is essential. In areas of forest where fires are common, CH<sub>4</sub> and N<sub>2</sub>O may also need to be measured. In addition, CH<sub>4</sub> may also need to be measured in forest areas with many peat bogs. Whether measurements of CH<sub>4</sub> and N<sub>2</sub>O sources should be carried out depends on the contribution of each source to total greenhouse gas emissions <sup>1)</sup>. Figure T02-1 shows the results of preliminary calculations of the contributions of different sources to total greenhouse gas emissions using Intergovernmental Panel on Climate Change (IPCC) default values and observed values in the field <sup>2)</sup>.

Moreover, once it is determined that measurements are required, the implementation of monitoring may be difficult. The stock change method is available for monitoring CO<sub>2</sub> (see Chapter 5), but a flux method must be used for CH<sub>4</sub> and N<sub>2</sub>O. However, training personnel to use an analytical instrument such as a gas chromatograph to measure gas fluxes is time consuming and expensive. Moreover, field observations and measurements usually need to be made frequently, as often as once every two to four weeks. To hold down monitoring costs, it may be possible to use flux values already

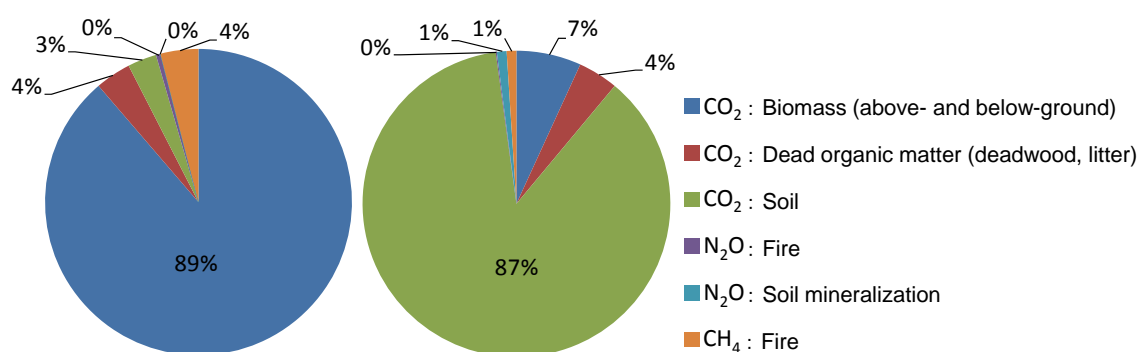

Figure T02-1 Estimation of contribution of subcategories to total greenhouse gas emissions <sup>2)</sup>

Tropical monsoon forest (Left: 425 t-CO<sub>2</sub>/ha/10 yr in total)

Peat swamp forest (Right: with drainage treatment: 878 t-CO<sub>2</sub>/ha/10 yr)

obtained by a university or other research institution in the project area, or, if no measurements are available, use of the default IPCC emission factors should be considered <sup>3)</sup>. Here, the focus is on the stock change method, the implementation of which is feasible for many projects. For information about the flux method, the reader is directed to the literature <sup>4)</sup> (Figure T02-2).



Figure T02-2 Measurement of greenhouse gas by flux method <sup>4)</sup>

- A) Settlement of chamber
- B) Suction of greenhouse gas by cylinder
- C) Filling of evacuated vial with greenhouse gas

## Five forest carbon pools

In the carbon stock method, forest ecosystems are regarded as consisting of five carbon pools <sup>5)</sup>: above-ground biomass, below-ground biomass, dead wood, litter, and soil organic matter <sup>5)</sup>. It is important to know the relative contribution of each pool to forest carbon stocks. In the example of a tropical seasonal (i.e., deciduous) forest (left pie chart in Figure T02-1), the contributions of CO<sub>2</sub> derived from above-ground and below-ground biomass are large, and the estimation accuracy of total emissions will be improved by measuring these directly rather than using default emission factors. On the other hand, the contribution of CO<sub>2</sub> from soil (peat) is more important in a peat bog forest (right pie chart in Figure T02-1). Measurement of above-ground and below-ground biomass for the stock change method is explained in P10 and P11. Forest carbon stocks of dead plants or soil can be evaluated similarly, by assessing the carbon stocks per unit area (t-C/ha) and multiplying that value by the forest area (ha). Therefore, if the concept of the stock change method is understood, which carbon pools to measure can be decided according to the relative contribution (priority) of each greenhouse gas source.

### Bibliography

GOFC-GOLD (2011) A sourcebook of methods and procedures for monitoring and reporting anthropogenic greenhouse gas emissions and removals caused by deforestation, gains and losses of carbon stocks in forests remaining forests, and forestation: GOFC-GOLD Report version COP17-1. GOFC-GOLD

### INFO

3) The emission factor database is available at <http://www.ipcc-nggip.iges.or.jp/EFDB/main.php>

### INFO

4) Sakata T, Ishizuka S, Takahashi M (2004) A method for measuring fluxes of greenhouse gases from forest soils. Bulletin of FFPRI 392: 259-265

### INFO

5) By the stock change method, the calculated annual change in a carbon pool (t-C/ha) is converted into the annual change in CO<sub>2</sub> (t-CO<sub>2</sub>/ha) by multiplying it by the factor 44/12.

## Attainable resources

The preceding Recipe is

Recipe P09 Estimation of carbon stocks per unit area

To estimate forest carbon stocks as required in REDD-plus, certain information and technical resources and a biomass estimation model for the implementation country are needed. The state of preparation of each implementation country and the availability of a suitable model must be ascertained, and then the methods and techniques used for forest carbon stock estimation should be selected by taking into account the resources that are available or attainable.

### Remote sensing resources

As a result of recent advances in remote sensing technologies, many improvements in ground-surface and wavelength resolution have been achieved, and many different types of sensors are available. A satellite equipped with high-resolution optical sensors can now image the ground surface with a resolution of about 50 cm, which means that it has the ability to observe individual tree crowns. The per unit area cost of an image, however, tends to increase with increases with the ground-surface resolution. For observations of forests in tropical areas, remote sensing with radar technology has the advantage that the radar waves can penetrate clouds, making observation possible on cloudy days. In forest areas, however, topographical features may influence the result, and, moreover, radar technology is not suitable for observations of above-ground biomass in a high carbon stock area. Progress in the development of correction factors for atmospheric or geometric distortions, however, have improved the accuracy of observations.

Thus, remote sensing technology has advantages and disadvantages depending on the sensor and the analysis method used. Therefore, whether remote sensing technology should be applied and the choice of sensor should be decided after considering the scale of the necessary observations and natural conditions in the region (see T05).

### Field survey resources

To calculate forest carbon stocks per unit area, it is necessary to know whether a biomass estimation equation has been developed for the country in question and whether National Forest Inventory (NFI) (see T01) data are available. If both of these are available in the implementation country, they can be used to calculate the forest carbon stocks.

If no NFI data are available in a country that is implementing REDD-plus, a permanent sample plot (PSP) survey system must be designed and established so that forest data can be collected (see P10 and T12-T14). Moreover, if a REDD-plus implementation country lacks a statistical model for computing biomass or carbon stocks, a model suited to the country must be developed (see P11 and T15-T19).

## Continuity of resources

---

In REDD-plus, future emissions are predicted from past changes of forest carbon stocks. Since the difference between the future predicted value and the forest carbon stocks at present is the basis for economic incentive grants by REDD-plus, the past trend and the future monitoring results must be comparable. In choosing the technique to use to determine forest carbon stocks, it is important to evaluate whether that technique can continue to be used in the future, from the point of view of technical and cost considerations. In addition, the consistency and reliability of the remote sensing technique used to detect changes in the forest area serve as the foundation for a third party review. Such consistency and reliability cannot be achieved if different techniques are used at different times.

## Voluntary carbon credit certification system

The preceding Recipe is  
Recipe I04 Designing the forest  
monitoring system

Voluntary certification systems have been developed independently of the United Nations Framework Convention on Climate Change (UNFCCC) and the Kyoto Protocol to evaluate emission reduction and removal activities for the purpose of awarding credits, known as Verified Emission Reductions (VERs), that can be traded. Among these certification systems, the Verified Carbon Standard (VCS), which targets actions in the forest sector, including REDD-plus, has been adopted by many independent projects.

### The present status of the VER certification system

The Kyoto Protocol includes mechanisms for issuing and trading emission reduction credits; the Clean Development Mechanism (CDM) is typical. In this case, the obtained credit is called a Certified Emission Reduction (CER). On the hand, the credit by other voluntary system is called a Verified Emission Reduction (VER).

While CERs can be applied toward achievement (compliance) of UNFCCC or Kyoto Protocol reduction targets, VERs cannot be used for that purpose. Rather, they are applied toward achievement of voluntarily set reduction targets or Corporate Social Responsibility (CSR) actions. In Japan, J-VER is a widely recognized type of VER that can be issued when CO<sub>2</sub> removal is achieved in a forest.

Although REDD-plus has not yet been formally incorporated into the UNFCCC, advanced voluntary projects are being carried out in many countries. The VCS certification system is used by many of these voluntary projects.

### VCS

The VCS is a verification and certification standard for voluntary emissions and removals efforts, and a greenhouse gas accounting program with the same name was established in 2005. Its purpose is to promote actions that reduce CO<sub>2</sub> emissions through a market mechanism by verifying and issuing carbon credits (Verified Carbon Units or VCUs) that can be traded in voluntary markets. More recently, VCS has developed the Jurisdictional and Nested REDD-plus initiative (JNR) as an accounting and crediting framework for REDD-plus-related credits.

The VCS structure consist "VCS standard" <sup>1)</sup> which sets out the implementation rules of whole system and "Requirements" which provide the necessary information and implementation procedure under the VCS spectral scopes. Project requirements relating to REDD-plus set out in the AFOLU (Agriculture, Forestry and Other Land Use) Requirements <sup>2)</sup>. VCS has also

#### INFO

1) VCS (2012) VCS Standard v 3.2  
[http://v-c-s.org/sites/v-c-s.org/files/VCS%20Standard%2C%20v3.2\\_0.pdf](http://v-c-s.org/sites/v-c-s.org/files/VCS%20Standard%2C%20v3.2_0.pdf)

established "Methodologies" which sets out detailed procedures and equations for quantifying the greenhouse gas benefits of a specific project.

Table T04-1 lists approved methodologies related to REDD-plus activities and the applicability by region and forest type. Although development of methodologies is not easy, those that are already registered are easy to implement. A guidebook is available <sup>3)</sup> that assists project developers in the selection of methodologies.

## Future considerations

Voluntary projects implementing REDD-plus activities are becoming more sophisticated, and many have adopted VCS. However, under the UNFCCC, REDD-plus is targeted at national or sub-national level implementation, not at individual projects using a VER-based certification system. How to later integrate these voluntary projects, which are carrying out meaningful forest conservation activities, with REDD-plus under the UNFCCC, is a challenge for the future.

The Japanese government has promoted the bilateral offset credit mechanism (BOCM) to counteract global warming. Incorporation of bilateral offset credit mechanism into REDD-plus is being considered, and bilateral offset credit mechanism guidelines and methodologies are being developed with that possibility in mind.

### INFO

2) VCS (2012) AFOLU Requirements  
<http://v-c-s.org/sites/v-c-s.org/files/AFOLU%20Requirements%20v3.2.pdf>

### INFO

3) Shoch D, Eaton J, Settelmyer S (2011) Project Developer's Guidebook to VCS REDD Methodologies  
[http://www.conservation.org/about/centers\\_programs/carbon\\_fund/Pages/resources.aspx](http://www.conservation.org/about/centers_programs/carbon_fund/Pages/resources.aspx)

Table T04-1 VCS Methodology and Applicability Conditions

Methodology No.	Type of REDD-plus Activity	Land Applicability	
		Region	Type of Forest
VM0003	Improved Forest Management (Extension in rotation age)	<i>No restriction</i>	<ul style="list-style-type: none"> <li>• Forests certified (or planned to be certified) by the FSC</li> <li>• Not including managed peat forest</li> </ul>
VM0004	Avoiding Planned Deforestation	Tropical Southeast Asia	<ul style="list-style-type: none"> <li>• Tropical peat swamp forests</li> <li>• Not including human settlement</li> </ul>
VM0005	Improved Forest Management (Conversion of low productive to high productive forest)	Tropical	<ul style="list-style-type: none"> <li>• Evergreen tropical rainforests</li> <li>• Not including peatland (or emissions associated with peatland are not significant)</li> </ul>
VM0006	Avoiding Mosaic Deforestation and Forest Degradation	<i>No restriction</i>	<ul style="list-style-type: none"> <li>• <i>No restriction</i></li> </ul>
VM0009	Avoiding Mosaic Deforestation and Forest Degradation	(If the soil carbon pool is selected,) Tropical or semi-arid tropical	<ul style="list-style-type: none"> <li>• Not including organic or peat soil</li> <li>• Not including forest designated for legally sanctioned logging activities</li> </ul>
VM0010	Improved Forest Management (Conversion from logged to protected forest)	<i>No restriction</i>	<ul style="list-style-type: none"> <li>• Not including wetland or peatland</li> </ul>
VM0011	Improved Forest Management (Conversion from logged to protected forest)	Tropical	<ul style="list-style-type: none"> <li>• Evergreen tropical forests, Moist deciduous forests, Tropical dry forests and Tropical upland forests</li> <li>• Forests designated for sanctioned selective logging</li> </ul>
VM0012	Improved Forest Management (Conversion from logged to protected forest)	Temperate and Boreal	<ul style="list-style-type: none"> <li>• Private ownership properties</li> <li>• Not including managed peatland forest</li> </ul>
VM0015	Avoiding Unplanned Deforestation	<i>No restriction</i>	<ul style="list-style-type: none"> <li>• Not including forested wetland growing on peat</li> </ul>

## Bibliography

VCS homepage: <http://v-c-s.org/>

J-VERhomepage: <http://www.j-ver.go.jp/>

# 7

## Chapter 7 Estimation of forest area using remote sensing





When measurement, reporting, and verification (MRV) of forest carbon stocks are performed for REDD-plus, forest carbon stocks must first be estimated at the national level. Under the United Nations Framework Convention on Climate Change (UNFCCC), use of remote sensing and a ground-based inventory in combination is recommended for this purpose. In particular, remote sensing should be used to clarify the forest types present and area occupied by each type. This chapter presents the fundamental knowledge and methods required to determine the area of each forest type by using remote sensing technology. In addition, methods of combining remote sensing with a field survey and estimating forest carbon stock per unit area are also introduced. Detailed explanations of these methods are given in Chapter 9.

- T05 Remote sensing and sensor types, and image data selection
- T06 Clouds and seasonality differences in images
- T07 Definition of a land cover class
- T08 Ground truth
- T09 Classification methods
- T10 Accuracy evaluation
- T11 Estimation of forest area change

## Remote sensing and sensor types, and image data selection

The preceding Recipe is

Recipe P08 Area estimation using remote sensing

To determine forest area, forest type, and degree of forest degradation from remote sensing image data, the image must have been acquired by a sensor suitable given the purpose of the measurements and the sizes of the target area and object. In this section, basic information about the main optical satellite sensors, including both technical specifications and costs, and the selection of image data and analysis software is presented.

### Platforms

Remote sensing sensors are mounted on a platform such as a satellite or an aircraft. Continuous earth observations are made from meteorological satellites in geostationary orbit, the platform most distant from the earth. Geostationary satellites appear to occupy a fixed position in the sky about 35,800 km above the equator. In contrast, an earth observation satellite follows a circular orbit from 450 to 1,000 km above the surface and observes the same point periodically. If the earth observation satellite sensor has the pointing capability, or it can tilt itself perpendicular to the orbit, it can observe a given point more frequently than the satellite revisit time. Aircraft observations can be made from a helicopter, which flies at altitudes from hundreds to thousands of meters above the ground, or from a fixed-wing aircraft (e.g., a propeller plane or a jet), which flies at altitudes of 1,000–20,000 m. Furthermore, observations from near the earth's surface can be made from a tethered balloon, a radio-controlled machine, an unmanned aerial vehicle (UAV), a cherry picker, or a person standing at a distance.

If the platform is close to the earth's surface, detailed observations are possible, but a large area cannot be overlooked at once. In contrast, a large area can be observed at once from a platform far above the earth, but fewer details can be distinguished. Thus, there is a trade-off between the area that can be observed and the level of detail that can be captured. Therefore, remote sensing sensors are mounted on various platforms at different altitudes, depending the purpose of the observation. Observations from platforms other than a satellite are performed as needed, and the sensor and the observations made can therefore be selected according to type and amount of data needed. On the other hand, a cost is incurred each time observations are made.

## Sensors

A sensor is a device that observes electromagnetic waves reflected from or emitted by the target. Sensors can be either passive or active. Common passive sensors are analog and digital cameras, which capture sunlight or artificial light reflected off the target (electromagnetic waves emitted from the target depending on the observation wavelength band). Optical sensors used for earth observation are passive sensors. In contrast, active sensors send electromagnetic waves toward a target and observe their reflection. Common examples are a weather radar and a laser range finder. For earth observation, Synthetic Aperture Radar (SAR) and Light Detection And Ranging (LiDAR) are used.

An optical sensor detects the intensity of visible to infrared light in one or more wavelength bands. Optical sensors typically detect reflected light in the visible (wavelength, 0.4–0.7  $\mu\text{m}$ ), near-infrared (0.7–1.3  $\mu\text{m}$ ), short-wavelength infrared (1.3–3  $\mu\text{m}$ ), mid-wavelength infrared (3–8  $\mu\text{m}$ ), or emitted light in the far or thermal infrared (8–14  $\mu\text{m}$ ) wavelength bands. Ground resolution, wavelength resolution, and time resolution differ among sensors. Recently developed sensor can make detailed, high-resolution observations. Optical sensors can be mounted on a satellite or an aircraft or they can be handheld by a person. Collection of data by an optical sensor has many advantages. An optical image can be understood intuitively because it resembles what we see with the human eye, and if the data are visualized as a monochrome or an RGB color composite image, land-cover types can be easily distinguished by their characteristic reflections (spectral pattern) and texture. Thus, optical sensors have been the most-used type of sensor until now. On the other hand, an optical sensor has the disadvantages that cloud cover and haze or dust can obscure the earth's surface or cause the data to be noisy, and that visible and reflective infrared wavelength bands cannot be used for nighttime observations when there is no sunlight.

Synthetic Aperture Radar (SAR) is an active sensor mounted on either a satellite or an aircraft, which emits microwave pulses (wavelength about 7–1,000 mm) obliquely, then detects and records the intensity, phase, and time of the reflected pulses from the earth's surface (backscatter). Some SAR sensors can also observe polarization. Sizes, configurations, densities and dielectric properties of the objects affect the backscattering's pattern, by which the objects are identified. Characteristics of the backscatter from a target depend on the wavelength band of the sensor. When a forest is observed using the L band (wavelength about 150–300 mm) or the P band (300–1,000 mm), the backscatter has three main components: reflections from the earth's surface or a tree crown or forest canopy (surface scattering); reflections from leaves within the canopy (volume scattering); and double-

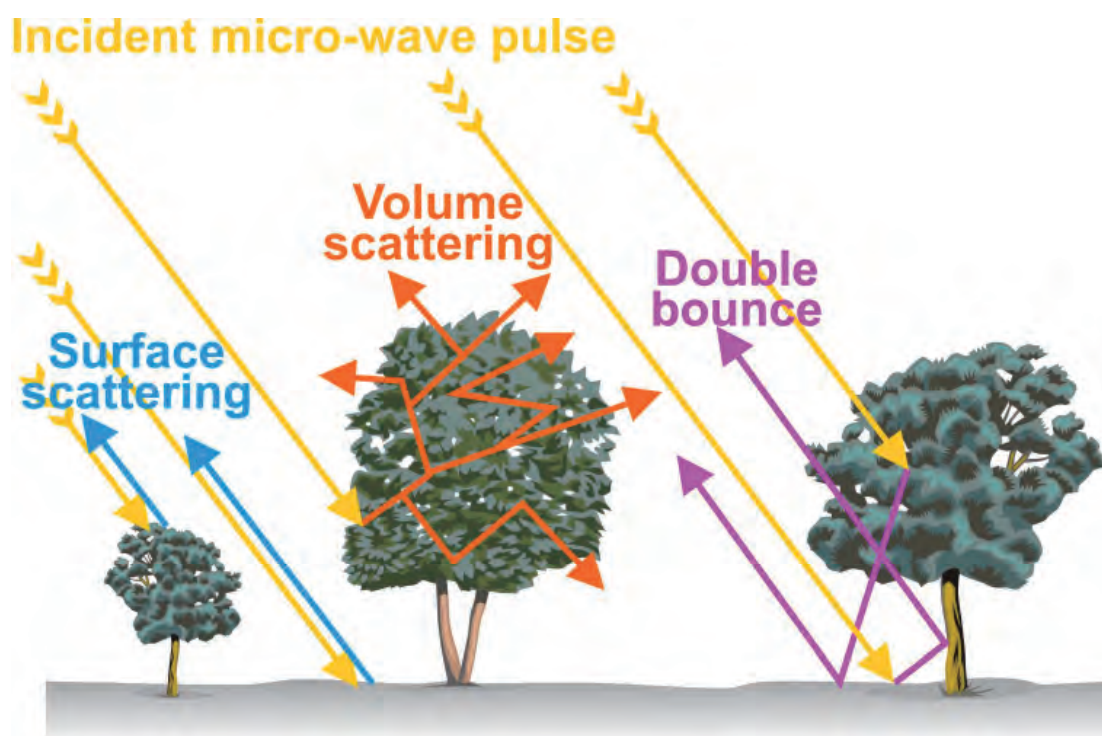

Figure T05-1 Three components of the SAR backscattering from forest

bounce reflections, when the microwaves are reflected twice (e.g., first from the ground surface to a tree trunk, or from the leaves to the ground surface, and then back to the sensor) before returning to the sensor (Figure T05-1). Research to interpret the state of the forest (species, biomass, etc.) from this information is ongoing. Moreover, changes in the elevation of the measurement surface can be detected by interference analysis from observation data of a forest obtained at different times. Interpretation of this information might allow the detection of deforestation and forest degradation. Observations can be made both in the daytime and at night and in all weather conditions, because SAR is an active sensor and the microwaves can penetrate clouds. Therefore, SAR is expected especially suitable for application to tropical forest observation. However, it also has disadvantages. The resulting data cannot be understood intuitively, the backscattering mechanism is complicated and not completely understood, and the angled observation introduces distortion into the resulting images and also results in the existence of blind spots, portions of the surface that cannot be observed.

LiDAR emits laser pulses at a frequency of tens to hundreds of kilohertz. It measures the distance from the sensor to the target by the traveling time and intensity of the reflected pulse from the target. Airborne LiDAR typically emits the laser pulses continuously over an angle of several tens of degrees to both

sides of the sensor perpendicular to the direction of movement, which allows the sensor to measure distribution of the earth's surface elevation three-dimensionally. The geometric accuracy of the measurement is assured by the inertial measurement unit (IMU) <sup>1)</sup>, which measures the position of the sensor and its inclination. The elevation of the earth's surface can be measured at higher resolution by using a higher-frequency laser pulse emitted at lower altitude. When the LiDAR is aimed at a forest, these laser pulses can be reflected by the tree canopy surface, the leaves within the canopy, or the earth's surface. A digital surface model (DSM) of the tree canopy can be created from the firstly returned components of the reflected (first pulse), while a digital terrain model (DTM) of the ground surface can be created from the lastly returned components (last pulses). Then, by subtracting the DTM from the DSM, a digital crown model (DCM) can be obtained, which can

#### INFO

1) Inertial measurement unit (IMU): Precise position and posture measuring device which combined global navigation satellite system (GNSS) and an inertial navigation system. GPS of the United States, European GALILEO, GLONASS of Russia, Hokuto Compass in China, etc. name GNSS generically.

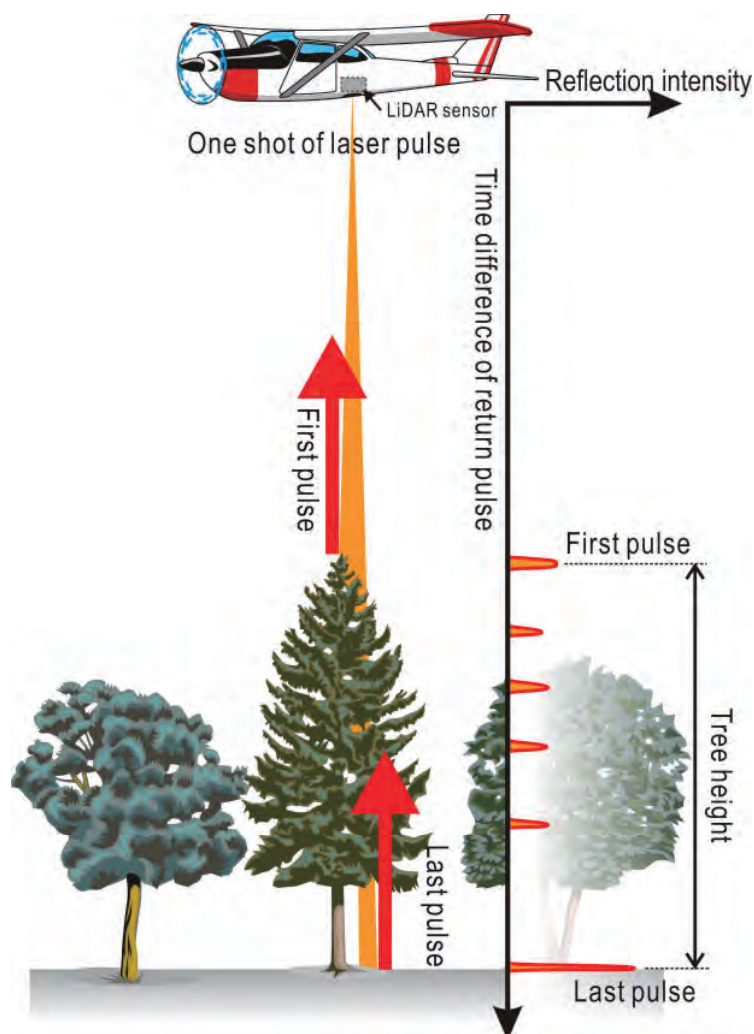

Figure T05-2 Concept of data acquisition by LiDAR

be used to determine the height of a single tree or the stand height (Figure T05-2). This information can then be used to estimate the stand biomass. Moreover, since the pulses returned between the first and last pulses are reflected by the interior of the tree canopy or by the understory vegetation, the three-dimensional structure of the forest can be determined in detail from them.

To obtain high-resolution data, the aircraft must fly at both low altitude and low speed, which results in the observations of a large area time consuming and expensive, or even impossible in mountainous areas. Other disadvantages of LiDAR include the inability to penetrate clouds or fog and the data processing time/costs because of the huge amount of observational data.

### **Spatial resolution, wavelength resolution, and time resolution**

Spatial resolution (how small an object can be recognized), spectral resolution (how many subdivisions of the wavelength range can be observed), and temporal resolution (the frequency with which the same area can be observed) determined the performance of a sensor. A suitable sensor should be chosen according to the target, the purpose, and the scale (area) of the observation. Spatial resolution typically varies from several centimeters to about 1 m in aerial photographs, and from 40 cm to several kilometers in satellite sensor images; temporal resolution ranges from one day to tens of days; and spectral resolution ranges from one band extending over the entire wavelength range of the sensor to hundreds of bands.

A high spatial resolution image with a resolution of 1 m or less is required to acquire information about individual trees. Therefore, if the targeted area is large, the data volume becomes huge and data processing is difficult. Moreover, because the area that can be observed at one time becomes smaller as the spatial resolution becomes higher, it becomes more difficult to cover a large area in a short period as the spatial resolution becomes higher. For acquisition of information about a stand, a medium-resolution image, one having a spatial resolution of about 10 m to several tens of meters, may be suitable, but to be able to distinguish among stands to detect different degrees of degradation, the spectral resolution must be high. If the purpose is only to distinguish forest from non-forest, a sensor with a visible and a near-infrared wavelength bands is sufficient.

When the target is forest, it is often assumed that the temporal resolution does not need to be very high. For a satellite-borne optical sensor, however, the time resolution needs to be considered in conjunction with the frequency over which the data can be actually acquired. If the whole target region

cannot be observed at one time, it is necessary to create a mosaic of multiple observations obtained at around the same time. Therefore, in the tropics and monsoon regions, where clouds often obscure the view of the earth's surface from the sky, a sensor with high temporal resolution is advantageous. The temporal resolution can be increased if oblique observation is possible or if they are made by two or more satellites.

## Present, past, and future

Archived remote sensing images can be viewed as a time machine that travels back into the past. No other data source has recorded such accurate temporal and spatial information about the past. Records from the Multispectral Scanner System (MSS) on-board Landsat 1, the world's first earth observation satellite, go back to the 1970s. However, naturally, the farther back in the past the record was obtained, the more likely it is that the performance of the sensor deteriorated or that the sensor failed. Thus, the sensor type might change or the images may be acquired less frequently with time and the area covered may become smaller. The image data captured by each sensor may have been stored by the organization that acquired them or archived in an archive center. Recently, data from many sensors and platforms have been made available on the Web, where they can be searched and downloaded.

With regard to future acquisition of image data, orders for data acquisition can be made in advance for additional cost for certain types of sensors/satellites.

## Selection of image data

Available optical sensor data collected by satellite-borne sensors are summarized in Table T05-1. Landsat satellite imagery in the archive of the United States Geological Survey (USGS) is downloadable for free from the USGS website. On the landsat.org homepage (<http://landsat.org>), some of orthorectified Landsat images are also available for free download. However, not all Landsat images are stored in the USGS archive, so it is necessary to search the websites of the organizations distributing image data for each country, and there is usually a charge for such data. Moreover, it may be necessary to purchase satellite imagery acquired by corporations, such as GeoEye, DigitalGlobe, SpotImage, or from local agencies.

## Software

---

General photo retouch software can be used for simple and/or elementary processing such as color composite displaying. For advanced processing and analyses, however, specialized remote sensing image-analysis software is required. Freeware or open source software, which often work as well as commercial software, are also increasingly available for this purpose. Although price may be a constraining factor in selecting software, it is important to consider, in addition to the purchase price, the support system, update frequency such as bug fixes, the existence of a user community, and the provision of training. In general, it is an advantage for people in the same work group or organization to use the same software, because they can help one another and questions can be answered immediately.



Table T05-1 Specifications and prices of major space-borne optical sensors

(prices are in Japan, as of July 2012)

Satellite	Sensor	Launched year	Terminated year	Spatial resolution	Swath (km)	Off-nadir observation	Spectral bands (number of bands)	Altitude (km)	Revisit (nadir) (day)	Revisit (day)	Acquisition by order	A full-scene price (JPY)	Per-area price (JPY/km <sup>2</sup> )	Operator	Notes
Landsat 1-3	MSS	1972	1983	68×83m	185		VIS(2), NIR(2)	915	18	18		40,740 a)	1.3	NASA/USA	a) Data for free of charge available at USGS ( <a href="http://glovis.usgs.gov/">http://glovis.usgs.gov/</a> , <a href="http://earthexplorer.usgs.gov/">http://earthexplorer.usgs.gov/</a> )
Landsat 4-5	MSS	1982	1995 b)	68×83m	185		VIS(2), NIR(2)	705	16	16		40,740 a)	1.3	NASA/USA	b) partially re-started in 2012
	TM	1982	- c)	30m (Band 6: 120m)	185		VIS(3), NIR(1), MIR(2), TIR(1)				88,200 a)	2.8	c) inactive since 2011		
Landsat 7	ETM+	1999	- d)	30m (Band 6: 60m, Band 8: 15m)	183		VIS(3), NIR(1), MIR(2), TIR(1), VIS - NIR(1)	705	16	16		88,200 a)	2.8	NASA/USA	d) SLC-off since 2003
EO 1	ALI-Pan, MS	2000	-	MS: 30m Pan: 10m	37		Pan: VIS(1) MS: VIS(4), NIR(3), MIR(3)	705	16	16		0	0	NASA/USA	Data available for free of charge at <a href="http://eo1.usgs.gov/">http://eo1.usgs.gov/</a>
	Hyperion			30m	7.5		VIS - MIR(220)			16					
EOS-Terra/ EOS-Aqua	MODIS	1999	-	250m/500m/1km	2,330		250m: VIS(1), NIR(1) 500m: VIS(2), NIR(1), MIR(2) 1km: VIS(7), NIR(5), MIR(9), TIR(8)	705	16	16		0	0	NASA/USA	Data available for free of charge at <a href="http://reverb.echo.nasa.gov/reverb/">http://reverb.echo.nasa.gov/reverb/</a>
SPOT 1-3	HRV-XS, P	1986	1993	XS: 20m P: 10m	60	✓	XS: VIS(2), NIR(1) P: VIS(1)	822	26	3.7		294,000 e)	8.2	Spot Image f)/ France	e) SPOT Scene level 2A, the same price for both XS and P f) now Astrium
SPOT 4	HRVIR-X, M	1998	-	X: 20m P: 10m	60	✓	X: VIS(2), NIR(1), MIR(1) M: VIS(1)	822	26	3.7	✓	294,000 g)	8.2	Astrium/ France	g) SPOT Scene level 2A, the same price for both XS and P
SPOT 5	HRG-X, P	2002	-	X: 10/20m P: 5/2.5m	60	✓	X: VIS(2), NIR(1), MIR(1) P: VIS(1)	822	26	2-3	✓	521,850 h)	145.0	Astrium/ France	h) SPOT Scene level 2A, the same price for both X (10m resolution) and P (5m resolution)
SPOT 4-5	VEGETATION	1998	-	1.15km	2,250		VIS(2), NIR(1), MIR(1)	822	26	1		0	0	Astrium/ France	Data available for free of charge at <a href="http://free.vgt.vito.be/">http://free.vgt.vito.be/</a>
Pléiades	Pan/ Multi	2011	-	Pan: 0.7m Multi: 2.8m	20	✓	Pan: VIS - NIR(1) Multi: VIS(3), NIR(1)	694	26	1	✓		2800 i)	Astrium/ France	i) Archived, standard product
IRS 1A,1B	LISS-I, II	1988	2003	I: 73m II: 36.5m	I: 185 II: 37		VIS(3), NIR(1)	904	22	22		?		ISRO/ India	
				23.4/73m	100	✓	VIS(2), NIR(1), MIR(1)				817	24	3		128,100 j)
IRS 1C,1D	Pan	1995	2010	0.9km	1,500		VIS(2)					128,100 k)	26.1	ISRO/ India	k) PAN-70 acquired after April, 2001
IRS-P2	LISS-II	1994	1997	32×37m	131	✓	VIS(3), NIR(1)	817	24	5				ISRO/ India	
IRS-P6 (ResourceSat 1)	LISS-III, IV	2003	-	III: 23.5m IV: 5.8m	III: 140 IV: 23	✓	III: VIS(2), NIR(1), MIR(1) IV: VIS(2), NIR(1)	817	24	5		270,000 l)	13.8	ISRO/ India	l) LISS-III Multi 140 x 140km at EuroMap, 1EUR = 100JPY
MOS 1,1b	MESSR	1987	1996	50m	100		VIS(2), NIR(2)	909	17	17		2,310	0.3	NASDA m)/ Japan	m) now JAXA
ALOS	AVNIR-2	2006	2011	10m	70	✓	VIS(3), NIR(1)	692	46			26,250 o)	5.4	JAXA/ Japan	n) forward/ backward o) Level 1 standard products
	PRISM			2.5m	35	n)	VIS - NIR(1)			46	26,250 o)	21.4			
EOS-Terra	ASTER-VNIR, SWIR, TIR	1999	-	VNIR: 15m SWIR: 30m TIR: 90m	60	✓	VNIR: VIS(2), NIR(1) SWIR: MIR(6) TIR: TIR(5)	705	16		✓	10,290 p)	2.9	ERSDAC/ Japan	p) Level 1B
IKONOS 1	Pan/ Multi	1999	-	Pan: 1m Multi: 4m	11	✓	Pan: VIS - NIR(1) Multi: VIS(3), NIR(1)	681	11	1.6	✓	-	4,500 q)	GeoEye/ USA	q) Geo Product, Pan+Multi set price; minimum ordering area 25km <sup>2</sup>
QuickBird	Pan/ Multi	2001	-	Pan: 0.61m Multi: 2.5m	16.5	✓	Pan: VIS - NIR(1) Multi: VIS(3), NIR(1)	450	20	1 - 3.5	✓	-	3,400 r)	GeoEye/ USA	r) Standard Image Pan + 4-band Multi bundle price; minimum ordering area 25km <sup>2</sup>
GeoEye 1	Pan/ Multi	2008	-	Pan: 0.41m Multi: 1.65m	15.2	✓	Pan: VIS - NIR(1) Multi: VIS(3), NIR(1)	684	11	3	✓	-	9,000 s)	GeoEye/ USA	s) Geo Product, Pan+Multi set price; minimum ordering area 25km <sup>2</sup>
WorldView 1	Pan	2007	-	0.5 - 0.59m	17.6	✓	VIS - NIR(1)	496		1.7	✓	-	2,800 t)	Digital Globe/ USA	t) Standard Image price; minimum ordering area 25km <sup>2</sup>
WorldView 2	Pan/ Multi	2009	-	Pan: 0.46m Multi: 1.84m	20	✓	Pan: VIS(1) Multi: VIS(5), NIR(3)	770		1.1	✓	-	6,400 u)	Digital Globe/ USA	u) Standard Image Pan + 8-band Multi bundle price; minimum ordering area 25km <sup>2</sup>
RapidEye 1-5 v)	Multi	2008	-	6.5m (5m after resampled)	77	✓	VIS(3), NIR(2)	630	5.5	1	✓	-	220 w)	RapidEye/ Germany	v) 5 satellites were launched at once w) minimum ordering area 500km <sup>2</sup>
THEOS	Pan/ Multi	2008	-	Pan: 2m Multi: 15m	Pan: 22 Multi: 90	✓	Pan: VIS - NIR(1) Multi: VIS(3), NIR(1)	822	26	2		75,000 x)	Pan: 155.0 Multi: 9.3	GISTDA/ Thailand	x) the same price for Pan and Multi; 100,000 JPY for the data acquired within the last 6 months
NOAA 6-19 y)	AVHRR	1979	-	1.1km	2,800		VIS(1), NIR(1), MIR(2), TIR(2)	814	0.5	0.5		0	0	NOAA/ USA	y) Weather satellites

## Clouds and seasonality differences in images

The preceding Recipe is

Recipe P08 Area estimation using remote sensing

Two major problems often arise when optical satellite imagery is used to observe a large area of the tropical forest: first, clouds may obscure the ground surface, and second, seasonal vegetation changes may be mistaken for different forest types when scenes from multiple images are used. In this recipe, some ways of coping with these obstacles are explained.

### Cloud removal

Clouds and haze and their shadows on the ground are obstacles to ground surface observation based on optical satellite images. In the tropics, in particular, overcast skies are common, and cloud-free satellite images are seldom obtainable.

Cloud removal is a set of processes that create a mosaicked cloud-free image by patching together the cloudless parts of multiple images acquired within a targeted time period. The first step is to detect and remove clouds, haze, and their shadows from each image (Figure T06-1). Visual interpretation on a display is a reliable technique for identifying and masking clouds, but manual interpretation requires a considerable amount of time and attention, especially when small clouds are scattered over the image. A realistic solution can be to combine visual interpretation with the use one of the available automatic cloud removing algorithms <sup>1)</sup>.

The next step is to mosaic together the cloudless image parts (Fig. T06-2). Although the mosaicked image shows the entire forest without clouds, because the images were acquired at different times, the image acquisition conditions, such as the direction and angle of the sun and seasonal vegetation characteristics, can differ in different parts of the mosaicked image.

#### INFO

1) Zhu Z, Woodcock CE (2012) Object-based cloud and cloud shadow detection in Landsat imagery. *Remote sensing of Environment* 118: 83-94

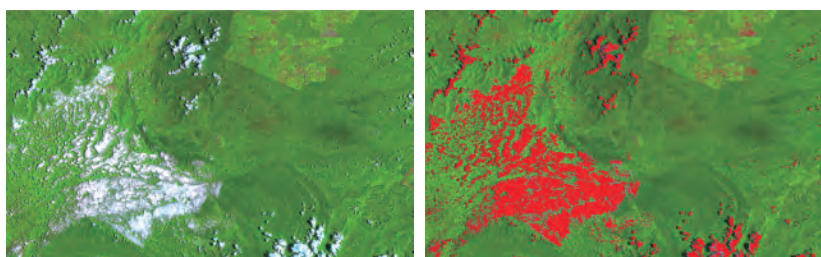

Original image

Clouds are masked out (red)

Figure T06-1 Cloud removal

Clouds are retrieved empirically by detecting appropriate threshold values. Landsat 7 ETM+ (Malaysia)

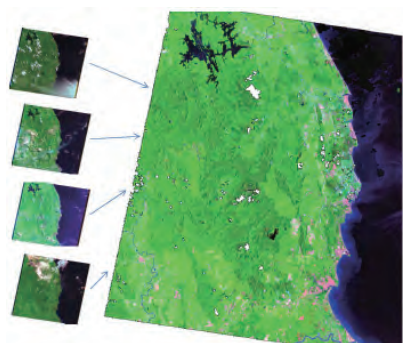

Figure T06-2 Cloud-free mosaicked image

This mosaic was created by replacing the cloud-covered parts of one image by the cloudless parts of three other images obtained for the same geographic area. Clouds were removed from each image automatically by using one of the available algorithms <sup>1)</sup>.

White patches in the mosaicked image are areas covered by clouds in all of the individual images. Landsat 7 ETM+ images (Malaysia)

## Seasonality adjustment

When the target forest area is larger than the area covered by a single satellite image scene, for example, when the target area is an entire country, then it is necessary to use multiple scenes. If images of the required scenes are obtained over a long time period, then the reflectance from the vegetation is likely to differ as a result of seasonal vegetation changes, especially in the case of forest types that show large seasonal changes each year. For example, in tropical seasonal forests, the forest canopy leafs out in the rainy season and drops its leaves in the dry season. The leafless forest can be misinterpreted or misclassified as bare soil or grassland, depending on the amount of understory growth. In addition, a mosaicked image of multiple scenes might show unrealistically abrupt discontinuities at borders between adjacent scenes if the scenes were obtained during seasons.

To avoid this problem, the images should be acquired during as short a time period as possible so that the seasonal changes are small. If that is not possible, then seasonal adjustment should be applied to the images before the land cover classification of the area is performed, or the classification should be applied to each image separately and then the separate land cover maps can be compiled to create a land cover map of the entire target area.

Histogram matching is a technique for adjusting seasonal differences among images. In this technique, the spectral reflectances of known and unchanged objects are compared among the images and then the reflectance histograms of the images are empirically adjusted to that of a reference image <sup>2)</sup>. Figure T06-3 shows an example of a pair of images before and after seasonal adjustment.

### INFO

2) Roy DP, Ju J, Lewis P, Schaaf C, Gao F, Hansen M, Lindquist E (2008) Multi-temporal MODIS–Landsat data fusion for relative radiometric normalization, gap filling, and prediction of Landsat data, *Remote Sensing of Environment*, 112: 3112-3130



(a) Original images (b) The upper image was adjusted to the lower

Figure T06-3 Seasonality adjustment (Langner, unpublished)

The upper and lower images were derived during the middle and at the beginning of dry season, respectively. The deciduous forests are already defoliated in the upper image, while they are still foliated in the lower image. After seasonal adjustment, the reflectance values of the upper image were adjusted to fit the lower.

© CNES2007, Distribution Astrium Services/ Tokyo Spot Image

## Definition of a land cover class

The preceding Recipe is

Recipe P08 Area estimation using remote sensing

To estimate the forest area by land cover classification of remote sensing data, mutually exclusive and collectively exhaustive land cover classes, such as forest, farmland, and urban, need to be defined. Here, what is meant by "mutually exclusive and collectively exhaustive" is explained and the design of a classification system and ways to improve classification accuracy are discussed.

### Mutually exclusive and collectively exhaustive classes

Land cover classes must be defined so that they are mutually exclusive and collectively exhaustive. Here, "collectively exhaustive" means that classes are defined so that all parts of the classification domain can be allotted to a class without any part being left unclassified. To achieve this, not only objects of interest but also objects of no interest must be classified. Moreover, classes must be "mutually exclusive," which means no overlap can be allowed between classes. Thus, one class cannot be a subset of another class. For example, forest and evergreen forest cannot both be defined as classes, because evergreen forest is just a part of forest.

Land cover classes can be viewed as having a hierarchical structure, and awareness of this structure is helpful for defining mutually exclusive and collectively exhaustive classes. For example, at the top level of the hierarchy, the classification system might include classes such as forest, farmland, and city, while in the level below that, the forest class might be divided into an evergreen forest class and a deciduous forest class <sup>1)</sup> (Figure T07-1). By taking account of this structure, in which the more inclusive classes at the top are divided into more detailed classes at a lower level, duplication and overlap between classes can be avoided.

#### INFO

1) Campbell JB (2006) Image classification In: Introduction to Remote Sensing Fourth Edition. Guilford Press, 324-366

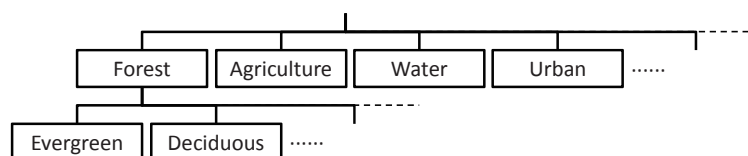

Figure T07-1 Hierarchical structure of classes

#### INFO

2) Cihlar J, Ly H, Xiao Q (1996) Land cover classification with AVHRR multichannel composites in northern environments. Remo Sens Environ 58: 36-51

### Desired and possible classification systems

Desired classes and classes that can actually be distinguished in remotely sensed data are not necessarily in agreement <sup>2)</sup>, and when they are not, it is

necessary to reconcile the two without introducing inconsistency into the existing classification system.

One way of accomplishing this reconciliation and meeting the needs of the user is to change the kind of remote sensing data, or the technique used to classify those data, from what is currently being used. For example, classification at a more detailed level is possible if data with a higher spatial resolution are used. In addition, how, for example, a deciduous forest appears depends on when the image was acquired. Therefore, by using images acquired at different times, classes of forest types such as deciduous and evergreen may become possible. Thus, both the data type and the classification technique should be selected at the time that the classes are defined.

### Integration of classes after classification

When classification based on remote sensing data with user-defined classes is difficult, classification accuracy may become low. In such a case, it may be possible to increase classification accuracy by merging two or more classes after the initial classification. However, care must be taken so that the merged class is not inconsistent with the existing classification system.

In addition, different areas that belong in the same class may not be classified into the same class because they appear different on the remote sensing image because of a difference in, for example, topographic features. For example, an area of forest on a sun-lit slope may appear different from a forest area on a shaded slope, and the two areas might be placed in different classes even though both areas should be classified as forest (Figure T07-2). In such a case, the separated classes, forest on a sunlit slope and forest on a shaded slope, can be merged during post-classification processing, which will increase the accuracy of the classification.

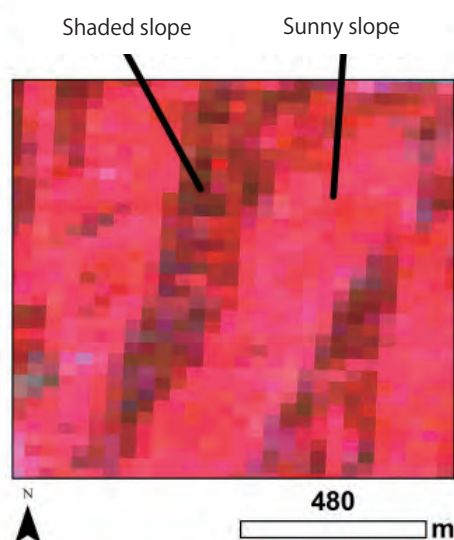

Figure T07-2 Forests on the sunny and shaded slopes

### Bibliography

Franklin SE (2001) Remote Sensing for Sustainable Forest Management. Lewis Publishers

## Ground truth

The preceding Recipe is

Recipe P08 Area estimation using remote sensing

Ground truths mean the actual terrestrial conditions at the target, and it is used to confirm classes and estimates based on remote sensing data and verify results. Collecting ground truths is referred as "ground truthing." Accuracies of not only the terrestrial conditions but also their geographical locations are required so that the ground truths can be exactly compared with the corresponding locations on the results from the remote sensing data. Sufficient numbers of ground truths should be allocated in a statistically sound manner so that the results of analysis are robust and unbiased.

### Ground truth

Ground truths mean information about actual terrestrial conditions observed, measured, and collected to confirm the correspondence between remote sensing data and the observation target. Ground truths are used as ancillary data for creating models to analyze the remote sensing data and verifying the results, such as collection of training and verification data from land-cover types to be used for land cover classification.

When ground conditions or limited accessibility make a field survey difficult, higher resolution satellite imagery, aerial photographs, and existing map information may be substituted for field data. Under such circumstances, these are also ground truths in the broad sense.

### Location of ground truth and its accuracy

Geographical coordinates of ground truths are often collected by using Global Positioning System (GPS), existing maps or interpretation of aerial photos or satellite images.

When using GPS, it should be noted that the accuracy under the canopy could be more reduced than open areas. Therefore, the position is identified by the combination of above methods depending on circumstances. The accuracy of the position information can be improved by enhancing the position accuracy of GPS using differential positioning or averaging positioning results. The required accuracy of position varies depending on the spatial resolution of the remote sensing data used. For the object based image analysis, it should be noted that ground truths should not span more than one segment. In addition, since the state of forest vegetation changes according to season within a year or from year to year, vegetation phenology (seasonal vegetation differences) must be taken into consideration, particularly when a vegetation index is used, or when the target forest is one that undergoes large seasonal changes, such as a tropical deciduous forest.

A camera with GPS, which can record the coordinate of shooting location directly on photograph, is a useful device to document the circumstances of ground truths.

### Sampling method

Ground truth must be sampled in a statistically appropriate manner. The sampling method

#### INFO

1) Jones HG, Vaughan RA (2010) Remote sensing of vegetation: Principles, techniques, and applications. Oxford University Press

#### INFO

2) Jensen JR (2005) Introductory digital image processing: a remote sensing perspective (Third edition). Prentice Hall

#### INFO

3) Hirzel AH, Guisan A (2002) Which is the optimal sampling strategy for habitat suitability modelling. Ecol Model 157: 331-341

has various ways such as a simple random sampling, stratified sampling, and systematic sampling, and each method has advantages and disadvantages <sup>1),2)</sup> (Figure T08-1, Table T08-1). Stratified sampling is an effective method for obtaining statistically valid results. To keep the number of samples from becoming too large while still obtaining a robust result, the number of samples collected from each stratum can be adjusted according to the total area to be sampled <sup>3)</sup>. Moreover, to keep costs from being excessive, stratified sampling can be combined with transect sampling across an environmental gradient <sup>4)</sup>.

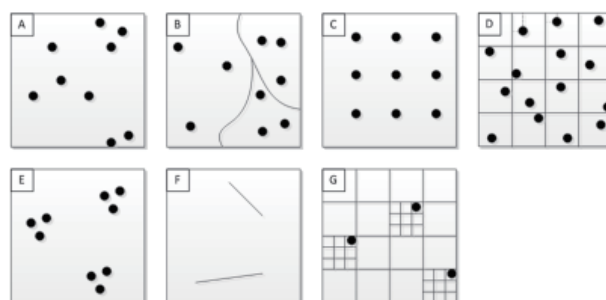

Figure T08-1 Sampling strategies.

Descriptions of A to G are shown in Table T08-1

## Number of samples

Required number of ground truths as the samples for supervised classification is assumed more than 10 times of the number of the explanatory variables used (e.g. number of spectral bands) <sup>1),2)</sup>. The more heterogeneous a sample is, the more number of samples are required. The number of ground truths per class as the samples for verifying the classification result is said to be more than 50, determined from a viewpoint of balancing between the statistical adequacy and the feasibility on the ground <sup>2),5)</sup>.

In addition, the ground truth used for verification should be independent from the one used for training, in order not to overestimate the model accuracy with the same training data.

### INFO

4) Wessels KJ, Jaarsveld AS, Grimbeek JD, Van Der Linde MJ (1998) An evaluation of the gradsect biological survey method. *Biodivers Conserv* 7: 1093-1121

### INFO

5) Congalton RG, Green K (1999) *Assessing the Accuracy of Remotely Sensed Data: Principles and Practices*. CRC Press

## Bibliography

McCoy RM (2004) *Field Methods in Remote Sensing*. Guilford Press

Table T08-1 Advantages and disadvantages of sampling strategies (blue words are modified after Jones and Vaughan, 2010)

Sampling strategies	Advantages	Disadvantages
A* Simple random	Statistically optimal. Minimum operator bias.	Possible inaccessibility of points in difficult terrain. Small but important categories may be undersampled or missed. Points not uniformly distributed over the entire study area.
B Stratified random	Reduce chance of undersampled categories Largely avoids operator bias. Often the most efficient strategy.	Possible inaccessibility of points. A thematic map covering the study area is additionally required for stratification.
C Systematic (Regular)	Ease of sampling. Evenly spread over area.	The process of selection can interact with hidden periodicities within the population (e.g., ridge and valley topography). Possible bias where linear landscape features exist. Over- or underestimation of categories occurs by their population size. Orientation and position of samples depend on the selection of the starting point.
D Systematic unaligned	Ease of sampling. Evenly spread over area. A degree of randomness is maintained within the constraints of the grid cell.	Possible bias where linear landscape features exist. Over- or underestimation of categories occurs by their population size.
E Cluster	Reduces travel cost in the field. Some combination of cluster and stratified sampling provides the best balance of statistical validity and practical application (Jensen, 2005).	Subject to spatial autocorrelation.
F Transect	Ease of access and sampling. Good where pre-existing gradients are known (e.g., altitude).	Subject to bias depending on how transects are chosen. Incomplete coverage.
G Multistage	Smaller sampling cost Normally more accurate than cluster sampling with the same sampling size. Effective for using satellite imagery with different spatial resolution.	Normally less accurate than simple or stratified random sampling with the same sampling size.

\*The letters A to G correspond to panels A to G in Figure T08-1.

## Classification methods

The preceding Recipe is

Recipe P08 Area estimation using remote sensing

To create a high-precision land cover map from satellite data, selection of an appropriate classification method is important. The classification methods are broadly divided into two types: supervised, which uses training data, and unsupervised. The minimum unit of classification can be a pixel or an object, the more conventional choice. Here, classification methods used for the analysis of satellite data are outlined.

### Classification in remote sensing

The process of assigning a land cover class to each pixel using its characteristics such as the spectral reflectance in satellite data is called land cover classification. Two statistical approaches used for land cover classification are supervised classification and unsupervised classification. Supervised classification uses training data (a set of data whose characteristics serve as a reference for designating classes), and unsupervised classification does not.

In supervised classification, a model for identifying a class (classifier) is built by using training data, and a class is assigned to each unknown pixel according to this model. The maximum likelihood method is often used for supervised classification of satellite image.

In unsupervised classification, the degree of similarity among pixels is determined by using only satellite image, and all pixels are divided into similar sets of pixels called clusters (clustering). Because this analysis method does not assign a class by itself (Figure T09-1), an analyst subsequently needs to interpret the result and to assign a class to each cluster or to groups of clusters. The results are interpreted by comparison with ground truths. ISODATA is a typical technique of unsupervised classification.

Other techniques, such as construction of a self-organization map, a classification tree, or a neural network can also be used for classification.

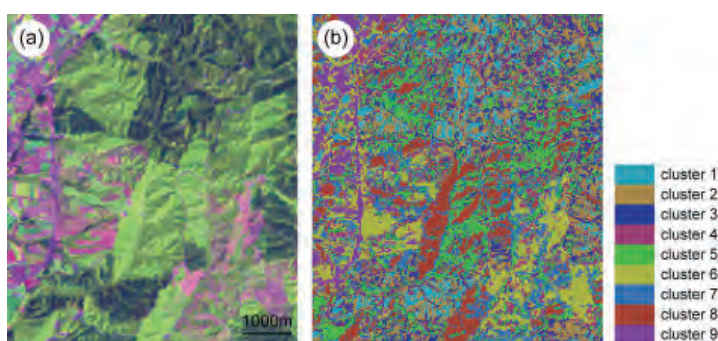

Figure T09-1 Unsupervised classification by ISODATA

(a) source image – Landsat ETM+

(b) resulted class map with 9 clusters

### Classification by pixel and object-based classification

In a forest, a pixel of medium-resolution satellite data (for example, 30 m × 30 m) represents solar radiation reflected from various parts of one or more tree crowns. The pixel may include parts of the crown illuminated by solar radiation and parts that solar radiation cannot reach. However, in the case of high-resolution satellite



data, a single pixel is smaller than a tree crown, so a pixel represents the reflection of solar radiation from only a small part of a tree crown. As a result, different pixels showing reflections from the same object (e.g., a tree crown) can have various values. The resulting internal class variance may become excessive, and cause it to be difficult to obtain a suitable classification result. To avoid this problem, object-based classification, in which groups of spatially adjoining pixels with similar feature values (obtained by a process called segmentation) are used as the minimum unit in the classification process.

In object-based classification, the pixel values used as feature values in pixel-based classification is used to calculate the average value of an object. In addition, various other characteristics of objects determined by segmentation, such as the variance of the pixel values and the texture and shape of the object, can be used in the classification. An advantage of object-based classification is that the segmentation process is unlikely to create a salt-and-pepper pattern scattered over the land cover map. Object-based classification is effective not only for high-resolution satellite images but also medium-resolution satellite images, and it has been used in the Global Remote Sensing Survey of the Global Forest Resources Assessment 2010 (FRA2010) <sup>1)</sup>.

Since segmentation results differ depending on the initial parameter settings in object-based classification (Figure T09-2), trial and error is used to determine the optimal parameter values. In addition, parameter values are peculiar to each data set, and thus suitable values must be selected for different data sets <sup>2)</sup>. The average land-use size of the target area, the minimum mapping unit, and other information should be also taken into account when the parameters are set.

Parameter values should be set by taking into consideration the average of the patch size of the target area, minimum mapping unit, and other information.

#### INFO

1) FAO, JRC, SDSU, UCL (2009) The 2010 Global Forest Resources Assessment Remote Sensing Survey: an outline of the objectives, data, methods and approach. Forest Resources Assessment Working Paper 155. FAO with FRA RSS partners

#### INFO

2) A scale parameter is a parameter that influences the size of the object output.

## Bibliography

Bishop C.M. (2006) Pattern Recognition and Machine Learning. Springer

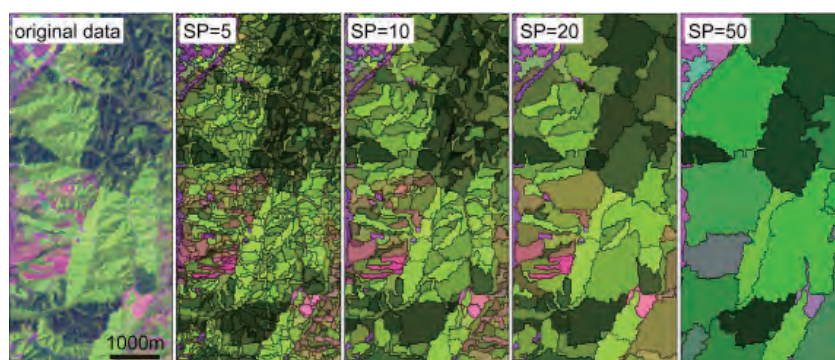

Figure T09-2 Results of segmentation with different scale parameters  
(original image: Landsat ETM+)

## Accuracy evaluation

The preceding Recipe is

Recipe P08 Area estimation using remote sensing

It is highly improbable that a land cover map obtained by image classification will perfectly represent the actual land cover distribution on the ground; rather, such a map is highly likely to contain errors and biases. The map producer should, therefore, provide accuracy information about the map so that it can be properly used for estimating land covers and land cover changes. This section outlines the assessment of classification accuracy and correction for biases in area estimates using the error matrix. In a real mapping project, an appropriate sampling design and a corresponding error estimation method should be applied to reduce the uncertainty of the error matrix.

### The error matrix and accuracy indicators

A point is correctly classified if the map class (i.e., the land cover class assigned by the classification procedure) is identical to the reference class (i.e., the real land cover class at that point on the ground). Conversely, a point is wrongly classified if the map class is not identical to the reference class (Figure. T10-1). Suppose an image is classified into  $r$  classes; then, an error matrix (or a contingency matrix) is derived as an  $r \times r$  matrix whose elements  $N_{ij}$  represent the area (i.e., number of pixels multiplied by the area per pixel) of map class  $i$  ( $1 \leq i \leq r$ ) and reference class  $j$  ( $1 \leq j \leq r$ ) (Table T10-1). In the matrix, the diagonal element  $N_{jj}$  ( $1 \leq j \leq r$ ) represents the area that is correctly classified into the reference class  $j$ , and  $N_{i.} = \sum_{j=1}^r N_{ij}$  is the area on the map that is classified into map class  $i$ .  $N_{.j} = \sum_{i=1}^r N_{ij}$  is the area on the ground that is actually in reference class  $j$ , and  $N = \sum_{j=1}^r \sum_{i=1}^r N_{ij}$  is the total area of the map.

Overall accuracy  $A$  : The ratio of the correctly classified area on the map, regardless of the map class, to total map area is 1 when the map perfectly agrees with the reality on the ground, and 0 when the map totally disagrees with reality. A target accuracy of  $A \geq 0.85$  is typical for many land cover mapping projects.

$$A = \frac{1}{N} \sum_{j=1}^r N_{jj} \quad (\text{T10-1})$$

User's accuracy  $au_i$  : The ratio of the area correctly classified into map class  $i$  to the total area classified into map class  $i$ .  $1 - au_i$  is called the commission error.

$$au_i = N_{ii} / N_{i.} \tag{T10-2}$$

Producer's accuracy  $ap_j$  : The ratio of the area correctly classified into map class  $j$  to the total area of reference class  $j$ .  $1 - ap_j$  is called the omission error.

$$ap_j = N_{jj} / N_{.j} \tag{T10-3}$$

Kappa coefficient  $K$  : An overall classification accuracy indicator, which takes into account the effect of coincidentally correct classification. The value

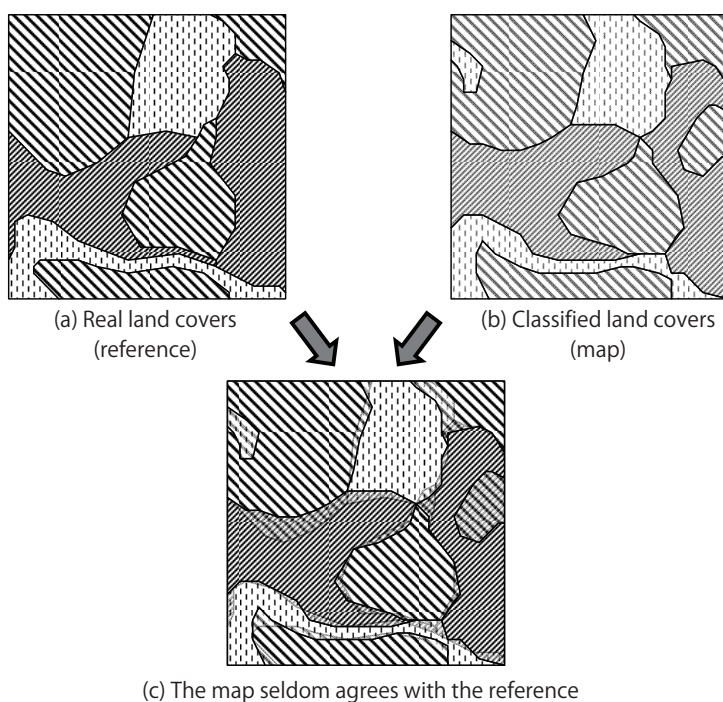

Figure T10-1 The real and classified land covers

The reference (a) is unknown actual mapping projects. To estimate the errors and biases of the map (b), the real land covers (i.e. ground truths) should be identified and compared with the classified land covers at sample points.

Table T10-1 Error matrix for a whole image – population

		Reference					Sum
		1	...	$j$	...	$r$	
Map	1	$N_{11}$	...	$N_{1j}$	...	$N_{1r}$	$N_{1.}$
	⋮	⋮				⋮	⋮
	$i$	$N_{i1}$		⋮		$N_{ir}$	$N_{i.}$
	⋮	⋮				⋮	⋮
	$r$	$N_{r1}$	...	$N_{rj}$	...	$N_{rr}$	$N_{r.}$
Sum		$N_{.1}$	...	$N_{.j}$	...	$N_{.r}$	$N$

has the range [0,1], and a higher value represents a better classification result.

$$\kappa = \frac{N \sum_{i=1}^r N_{ii} - \sum_{i=1}^r (N_{i.} N_{.i})}{N^2 - \sum_{i=1}^r (N_{i.} N_{.i})} \tag{T10-4}$$

### Uncertainty of the error matrix and ground truth

In the preceding section, a complete error matrix without uncertainty is derived under the assumption that the reference class is known at any given point on the map. That is, however, not the case for real mapping projects, in which we seldom have complete knowledge of the reference classes – otherwise we would not have to use remote sensing! Here, methods to statistically estimate the error matrix and the accuracy indicators by using ground truth data (see T08) are introduced. An appropriate sampling design and calculation procedure should be applied to properly reduce the uncertainty of the error matrix.

There are two basic sampling designs for obtaining ground truth data for accuracy assessment: simple random sampling (SRS) and stratified sampling (SS). In SRS, the sampling probability of map class  $i$  and reference class  $j$  is assumed to be proportional to the area  $N_{ij}$ . If available, extensive systematic sampling, such as a national forest inventory (see T01), can be used as the substitute of an SRS ground truth data set. When the sample size is small, the errors of classes occupying small areas might become relatively large.

In SS, an arbitrary number of samples is randomly allocated to each map class. In many mapping projects, ground truth data are allocated in this manner, because it can be a way to efficiently utilize the project resources.

Error matrices derived from SRS and SS are shown in Tables T10-2 and T10-3, respectively.

Let  $n_{ij}$  the number of samples in map class  $i$  and reference class  $j$ , then

Table T10-2 Error matrix for simple random samples

		Reference					Sum	
		1	...	$j$	...	$r$		
Map	1	$n_{11}$	...	$n_{1j}$	...	$n_{1r}$	$n_{1.}$	$N_{1.}$
	⋮	⋮				⋮	⋮	⋮
	$i$	$n_{i1}$		⋮		$n_{ir}$	$n_{i.}$	$N_{i.}$
	⋮	⋮				⋮	⋮	⋮
	$r$	$n_{r1}$	...	$n_{rj}$	...	$n_{rr}$	$n_{r.}$	$N_{r.}$
Sum		$n_{.1}$	...	$n_{.j}$	...	$n_{.r}$	$n$	
		$\hat{N}_{.1}$	...	$\hat{N}_{.j}$	...	$\hat{N}_{.r}$		$N$

Table T10-3 Error matrix for stratified samples

		Reference					Sum	
		1	...	<i>j</i>	...	<i>r</i>		
Map	1	$n_{11}$	...	$n_{1j}$	...	$n_{1r}$	$n_{1.}$	$N_{1.}$
	⋮	⋮				⋮	⋮	⋮
	<i>i</i>	$n_{i1}$		⋮		$n_{ir}$	$n_{i.}$	$N_{i.}$
	⋮	⋮				⋮	⋮	⋮
	<i>r</i>	$n_{r1}$	...	$n_{rj}$	...	$n_{rr}$	$n_{r.}$	$N_{r.}$
		$\hat{N}_{.1}$	...	$\hat{N}_{.j}$	...	$\hat{N}_{.r}$	$N$	

$n_{i.} = \sum_{j=1}^r n_{ij}$ ,  $n_{.j} = \sum_{i=1}^r n_{ij}$ , and  $n = \sum_{j=1}^r \sum_{i=1}^r n_{ij}$ . The total number of samples,

$n$ , in SRS, or in SS the number of samples in map class  $i$ ,  $n_{i.}$ , is set arbitrarily prior to the sampling.

The total map area,  $N$ , and the total area of each map class,  $N_{i.}$ , are already known. However, the total area of each reference class,  $N_{.j}$ , is unknown, even though often the goal of a mapping project is to estimate the areas occupied by different land covers on the ground. Thus, an estimate,  $\hat{N}_{.j}$ , of  $N_{.j}$  must be determined.

Let  $\pi_i$  the areal proportion of map class  $i$ , then  $\hat{p}_{ij}$ , an estimate of the areal proportion of a map class  $i$  and a reference class  $j$  is derived as follows:

$$\pi_i = N_{i.}/N \tag{T10-5}$$

$$\hat{p}_{ij} = \pi_i n_{ij}/n_{i.} \tag{T10-6}$$

Next, the accuracy indicators are estimated with their standard errors (*SEs*) as follows. Note that the equations marked with [SRS] or [SS] are calculations for the SRS or SS sampling designs, respectively, whereas the equations that are not marked are calculations common to both the SRS and SS designs.

Estimate of the area of reference class  $j$ <sup>1)</sup>:

$$\hat{N}_{.j} = N \sum_{i=1}^r \hat{p}_{ij} \tag{T10-7}$$

$$SE(\hat{N}_{.j}) = N \left\{ \sum_{i=1}^r \hat{p}_{ij} (\pi_i - \hat{p}_{ij}) / (\pi_i n) \right\}^{1/2} \text{ [SRS]} \tag{T10-8}$$

**INFO**

1) Card DH (1982) Using Known Map Category Marginal Frequencies to Improve Estimates of Thematic Map Accuracy. Photo Engin Rem Sens 48: 431-439

$$SE(\hat{N}_{.j}) = N \left\{ \sum_{i=1}^r \hat{p}_{ij} (\pi_i - \hat{p}_{ij}) / n_i \right\}^{1/2} \quad \text{[SS]} \quad \text{(T10-9)}$$

Overall accuracy <sup>1)</sup>:

$$\hat{A} = \sum_{i=1}^r \hat{p}_{ii} \quad \text{(T10-10)}$$

$$SE(\hat{A}) = \left\{ \sum_{i=1}^r \hat{p}_{ii} (\pi_i - \hat{p}_{ii}) / (\pi_i n) \right\}^{1/2} \quad \text{[SRS]} \quad \text{(T10-11)}$$

$$SE(\hat{A}) = \left\{ \sum_{i=1}^r \hat{p}_{ii} (\pi_i - \hat{p}_{ii}) / n_i \right\}^{1/2} \quad \text{[SS]} \quad \text{(T10-12)}$$

User's accuracy <sup>1)</sup>:

$$\hat{a}u_i = n_{ii} / n_i. \quad \text{(T10-13)}$$

$$SE(\hat{a}u_i) = \{ \hat{p}_{ii} (\pi_i - \hat{p}_{ii}) / (\pi_i^3 n) \}^{1/2} \quad \text{[SRS]} \quad \text{(T10-14)}$$

$$SE(\hat{a}u_i) = \{ \hat{p}_{ii} (\pi_i - \hat{p}_{ii}) / (\pi_i^2 n_i) \}^{1/2} \quad \text{[SS]} \quad \text{(T10-15)}$$

Producer's accuracy <sup>1)</sup>:

$$\hat{a}p_j = \frac{N_j \cdot n_{jj}}{\hat{N}_{.j} n_j} = \frac{N_j}{\hat{N}_{.j}} \hat{a}u_j \quad \text{(T10-16)}$$

$$SE(\hat{a}p_j) = \left\{ \hat{p}_{jj} \left( \frac{\hat{N}_{.j}}{N} \right)^{-4} \left[ \hat{p}_{jj} \sum_{i \neq j}^r \frac{\hat{p}_{ij} (\pi_i - \hat{p}_{ij})}{\pi_i n} + (\pi_j - \hat{p}_{jj}) \left( \frac{\hat{N}_{.j}}{N} - \hat{p}_{jj} \right) / (\pi_j n) \right] \right\}^{1/2} \quad \text{[SRS]} \quad \text{(T10-17)}$$

$$SE(\hat{a}p_j) = \left\{ \hat{p}_{jj} \left( \frac{\hat{N}_{.j}}{N} \right)^{-4} \left[ \hat{p}_{jj} \sum_{i \neq j}^r \frac{\hat{p}_{ij} (\pi_i - \hat{p}_{ij})}{n_i} + (\pi_j - \hat{p}_{jj}) \left( \frac{\hat{N}_{.j}}{N} - \hat{p}_{jj} \right) / n_j \right] \right\}^{1/2} \quad \text{[SS]} \quad \text{(T10-18)}$$

*khat* (estimate of the kappa coefficient) <sup>2), 3), 4), 5)</sup>:

$$\hat{\kappa} = \frac{n \sum_{i=1}^r n_{ii} - \sum_{i=1}^k n_i \cdot n_i}{n^2 - \sum_{j=1}^k n_i \cdot n_i} \quad \text{[SRS]} \quad \text{(T10-19)}$$

$$SE(\hat{\kappa}) = \left\{ \frac{1}{n} \left[ \frac{\theta_1 (1 - \theta_1)}{(1 - \theta_2)^2} + \frac{2(1 - \theta_1)(2\theta_1 \theta_2 - \theta_3)}{(1 - \theta_2)^3} + \frac{(1 - \theta_1)^2 (\theta_4 - 4\theta_2^2)}{(1 - \theta_2)^4} \right] \right\}^{1/2} \quad \text{[SRS]} \quad \text{(T10-20)}$$

**INFO**

2) Congalton RG, Green K (1999) Assessing the accuracy of remotely sensed data: principles and practices. CRC Press, 137pp

**INFO**

3) where,  $\theta_1 = \frac{1}{n} \sum_{i=1}^r n_{ii}$ ,

$$\theta_2 = \frac{1}{n^2} \sum_{i=1}^r n_i \cdot n_i,$$

$$\theta_3 = \frac{1}{n^2} \sum_{i=1}^r n_{ii} (n_i + n_i),$$

$$\theta_4 = \frac{1}{n^3} \sum_{i=1}^r \sum_{j=1}^r n_{ij} (n_i + n_j)^2$$

**INFO**

4) Stehman SV (1996) Estimating the Kappa Coefficient and its Variance under Stratified Random Sampling. Photo Engin Rem Sens 62: 401-407

**INFO**

5) where,  $\hat{D} = \sum_{i=1}^r \frac{N_i}{n_i}$ ,

$$\hat{G} = \sum_{i=1}^r N_i \cdot \hat{N}_{.i}, \quad f_i = \frac{n_i}{N_i},$$

$$\hat{V}_i = \frac{u_i^2 - n_i \cdot \bar{u}_i^2}{n_i - 1},$$

$$\bar{u}_i = 1/n_i \left\{ n_{ii} \left[ \frac{N}{N^2 - \hat{G}} \right] + \frac{N(\hat{D} - N)}{(N^2 - \hat{G})^2} \sum_{j \neq i} n_{ij} N_j \right\},$$

$$u_i^2 = n_{ii} \left[ \frac{N}{N^2 - \hat{G}} + \frac{N_i N (\hat{D} - N)}{(N^2 - \hat{G})^2} \right]^2 + N^2 \frac{(\hat{D} - N)^2}{(N^2 - \hat{G})^4} \sum_{j \neq i} n_{ij} N_j^2$$

$$\hat{\kappa} = \frac{N\hat{D} - \hat{G}}{N^2 - \hat{G}} \quad [\text{SS}] \quad (\text{T10-21})$$

$$SE(\hat{\kappa}) = \left\{ \sum_{i=1}^r N_i^2 (1 - f_i) \hat{V}_i / n_i \right\}^{1/2} \quad [\text{SS}] \quad (\text{T10-22})$$

Accuracies of classifications can be compared by using these estimates. For example, assume  $\hat{\kappa}_1$  and  $\hat{\kappa}_2$  are the khats from two different classification results; then the null hypothesis  $H_0: \kappa_1 - \kappa_2 = 0$  is rejected when the test statistic  $Z = \frac{|\hat{\kappa}_1 - \hat{\kappa}_2|}{\sqrt{\text{var}(\hat{\kappa}_1) + \text{var}(\hat{\kappa}_2)}}$ , is  $\geq Z_{\alpha/2}$  under the assumption of that  $Z$  is normally distributed, where  $Z_{\alpha/2}$  is the minimum value of  $Z$  for a significance level of  $100(1-\alpha)\%$ , which is equal to 1.96 or 2.58 when  $\alpha$  is 0.05 or 0.01, respectively.

On empirical grounds, a minimum of 50 samples is recommended for each land cover. If the area is especially large or there are a large number of land cover types, then the minimum number of samples should be increased to 75 or 100 per land cover <sup>2)</sup>. The ground truth data set for accuracy assessment should be different and independent from the ground truth data used as training data; otherwise the accuracy will be overestimated.

## Estimation of forest area change

The preceding Recipe is

Recipe P07 Stock change method

This recipe outlines approaches to estimating changes in forest area from a set of images obtained at different time points and problems associated with each approach. A single image shows the forest cover at only a single time point. Therefore, images acquired at two or more time points are needed to detect change in the forest. When a set of images obtained at different time points are available, two approaches can be used to reveal changes. In the first approach, each image is first classified, and then the classification results are compared to determine their differences (the change). In the second approach, the set of multi-temporal images is all classified together, then the changes are derived as a group of classes.

### Comparison after the classification of images acquired at two different times

To detect changes by comparing the classification results obtained by separately classifying images acquired at two different times, a cross-tabulation table (e.g., Table T11-1) is created and used to identify land covers before and after a change. This is key to understanding the amount of change that occurred. However, changes can be falsely identified along boundary between land covers when registration of the images to each other is not accurate enough (Figure T11-1).

Table T11-1 Error matrix for stratified samples

		Land covers in 2004			
		Forest	Non-forest	Water	Total
Land covers in 1990	Forest	606.9	90.5	0.0	697.4
	Non-forest	47.9	169.3	0.8	218.0
	Water	0.0	9.6	12.2	21.8
	Total	654.8	269.3	13.0	937.1

### Detection of land cover changes by multi-temporal classification

There are two multi-temporal classification methods that can be used to classify a set of multi-temporal images all together: in one, classification is performed on a differentiated image over the time period (in most cases, by calculating the difference between the two images, and in the other, the images are combined into a single multi-layer image, which is then used for the classification (Figure T11-2).

If multi-temporal classification of images in a block is performed by detecting changes and the training data are sampled from only changed



areas, then the land covers before and after the change cannot be identified. On the other hand, if the sampling is conducted to include land covers both before and after the change, a larger number of training samples is needed. Moreover, because the acquisition times of the images differ, changes of luminance due to seasonal differences (phenology differences) or topographic features may be mistaken for land cover changes.

## Some notes on the change detection

To use images acquired at different times to detect change, geometric registration of the images is extremely important. For a change detection error of less than 10 %, an accuracy of position of less than 0.2 pixel is needed <sup>1)</sup>. However, in GOF-C-GOLD, it is acceptable if the relative error of the two images is less than 1 pixel <sup>2)</sup>.

In the Remote Sensing Survey of Global Forest Resources Assessment (FRA) by the FAO, an object-based <sup>3)</sup> classification was applied to each of the time-series set of images, then the changes in forest area were determined by comparing the classification results from different years <sup>4)</sup>. In contrast, in GOF-C-GOLD, an object-based classification was applied to the time-series set of images all together to determine the forest changes through the time period <sup>2)</sup>.

### INFO

1) Dai X, Khorram S (1998) The effects of image misregistration on the accuracy of remotely sensed change detection. *IEEE Trans Geosci Rem Sens* 36: 1566-1577

### INFO

2) [http://www.gofcgold.wur.nl/redd/sourcebook/Sourcebook\\_Version\\_Nov\\_2011\\_cop17\\_1.pdf](http://www.gofcgold.wur.nl/redd/sourcebook/Sourcebook_Version_Nov_2011_cop17_1.pdf)

### INFO

3) An object is a group of spatially adjoining pixels that have a homogeneous spectrum. The process dividing an image into objects is referred to as "image segmentation."

### INFO

4) <http://www.fao.org/docrep/012/k7023e/k7023e00.pdf>

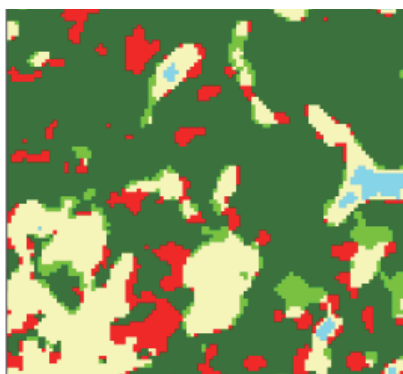

Figure T11-1 Comparison after the classification of images at the two times

Green: forest, yellow: non-forest, light blue: water, light green: change from non-forest to forest, red: change from forest to non-forest

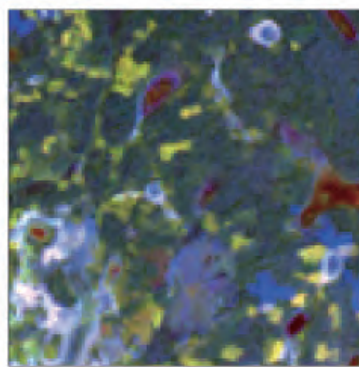

Figure T11-2 A multi-temporal image of two different dates. Changes appear in different colors on a multi-temporal image in which bands of different acquisition dates are assigned to different color channels. In this example, two Landsat TM images of different dates are used; red for Band 3 of the latter image, green for Band 5 of the former image, and blue for Band 5 of the latter image. Changes from forest to non-forest appear yellowish, while changes from non-forest to forest appear reddish, on this image.

## Bibliography

Campbell JB (2007) *Introduction to Remote Sensing*. Guilford Press

# 8

## Chapter 8 Permanent sample plot method



The most traditional and direct measurement technique for determining forest carbon stock involves the use of permanent sample plots (PSPs). The permanent sample plot method consists of 3 steps; design, field survey, and data analysis. In this chapter, firstly, how to design the permanent sample plot method, such as how many plots should be used and how to set up plots is explained. Secondly, how to determine the plot areas and the shape of plots, as well as technologies that will be useful for field survey are introduced. Lastly, important things that should be bore in mind when estimating carbon stocks per unit area using tree census data, especially how to select allometric equation that have a big influence on the calculation result, are explained.

T12 Selecting the number and arrangement of permanent sample plots

T13 Measurement of permanent sample plots

T14 Analysis of permanent sample plot data

## Selecting the number and arrangement of permanent sample plots

The preceding Recipe is

Recipe P10 permanent sample plot method

To estimate carbon stocks efficiently in a large area (national or sub-national level), stratified sampling based on a suitable forest classification method is effective. Here, how to obtain the required accuracy level, calculation of the required number of permanent sample plots for stratified sampling, and creating a matrix for suitable stratification are explained.

### INFO

1) Avery TE, Burkhardt HE (eds.) (1994) Forest measurements, Fourth edition. McGraw-Hill

### INFO

2) Brown S (2002) Measuring, monitoring, and verification of carbon benefits for forest-based projects. Phil Trans R Soc Lond A 360: 1669-1683

### INFO

3) Pearson T, Walker S, Brown S (2005) Sourcebook for land use, land-use change and forestry projects. Winrock International and the BioCarbon Fund of the World Bank

### Required accuracy

The required accuracy of a sampling method, that is, the permissible error  $E$ , is calculated as follows, provide that the population is sufficiently large <sup>1)</sup>.

$$E = \frac{t \cdot s}{\sqrt{n}} \quad (\text{T12-1})$$

Here,  $t$  is the  $t$  statistic value that is necessary for a 5% significance level of the  $t$ -distribution,  $s$  is standard deviation, and  $n$  is the number of samples. It is expressed as the error rate (%) which is calculated by dividing  $E$  by the average. According to the equation T12-1, the larger the number of samples ( $n$ ) becomes, the smaller the error ( $E$ ) becomes, but since a larger number of samples also increases the cost of the investigation, the permissible error rate should be selected after considering cost effectiveness. Previous experience suggest that the permissible error rate in a tropical forest is 10% or less <sup>2)</sup>.

Moreover, it is clear from this equation that the smaller the standard deviation ( $s$ ) becomes, the smaller the error ( $E$ ) becomes. Thus, the number of samples ( $n$ ) can be fewer and the estimation will be more cost efficient if the standard deviation ( $s$ ) is small. Stratified sampling, described below, is one way to reduce the size of the standard deviation ( $s$ ) <sup>3)</sup>.

### How to calculate the required number of permanent sample plots

When the target forest is large, it is likely to include different forest types (e.g., needle-leaf or broadleaf and evergreen or deciduous). Moreover, different parts of the forest may have been affected by different degrees of disturbance, or there may be differences in the successional stage among forests of the same type. Under these circumstances, stratified sampling is a very effective sampling strategy. In stratified sampling, the forest is classified into strata (layers) that are relatively homogeneous with respect to the forest type and state, and then the required number of permanent sample plots and their distribution in each stratum is considered.

Suppose that a forest is divided into  $L$  strata, the total required number ( $n$ )

of permanent sample plots is obtained as follows 4):

$$n = \left(\frac{t}{E}\right)^2 \left[ \sum_{h=1}^L W_h S_h \sqrt{C_h} \right] \left[ \sum_{h=1}^L W_h S_h / \sqrt{C_h} \right] \quad (T12-2)$$

Here,  $W_h$  is the ratio of the number of sampling units in each stratum  $N_h$  to the whole sample population  $N$  ( $W_h = N_h/N$ ),  $t$  is the value of the  $t$  statistic at the 5% significance level of the  $t$ -distribution with  $(n - L)$  degrees of freedom,  $S_h$  is the standard deviation of each stratum, and  $C_h$  is the cost of measuring the plots in each stratum. The number of samples ( $n_h$ ) assigned to each stratum is calculated as follows 5):

$$n_h = n \frac{W_h S_h / \sqrt{C_h}}{\sum_{h=1}^L W_h S_h / \sqrt{C_h}} \quad (T12-3)$$

If no information on costs is available, then  $C_h = 1$ , and if the sampling ratio ( $n / N$ ) is 5% or more the population is considered to be limited, then the required number of permanent sample plots is computed as the compensation value  $n_a$ , which is calculated as follows, using the value of  $n$  computed above 6).

$$n_a = \frac{Nn}{N + n} \quad (T12-4)$$

### Suitable stratification

The purpose of using stratified sampling is to raise the estimated accuracy or to decrease the number of sampling plots needed ( $n$ )<sup>3</sup>. Therefore, the forest should be stratified in such a way that the variation in each stratum ( $S_h$ ) is as small as possible compared with the variation in the whole population ( $s$ ). An effective means of stratification is to create a stratification matrix<sup>7</sup> shown in Figure T12-1. This matrix constructed with two axes: one axis shows forest types and the other shows the state or condition of the forest. Before constructing the matrix, it is important to understand what factors (e.g., altitude, soil type, land-use history) relate to spatial changes in carbon stocks<sup>7</sup>. Moreover, a stratification matrix is also an effective way to quantify degrees of forest degradation by forest type.

Forest type	Forest Condition			
	Mature	Logged	Secondary (young)	Secondary (med. aged)
Evergreen				
Deciduous				
Mixed				

Figure T12-1 Stratification matrix using forest type and forest condition (modified from Gibbs et al<sup>7</sup>)

#### INFO

4) UNFCCC "Calculation of the number of sample plots for measurements within A/R CDM project activities" <http://cdm.unfccc.int/methodologies/ARmethodologies/tools/ar-am-tool-03-v2.1.0.pdf>

#### INFO

5) An Excel sheet that can actually calculate the required number of permanent sample plots by stratified sampling is available the following URL: [http://www.winrock.org/ecosystems/files/Winrock\\_Sampling\\_Calculator.xls](http://www.winrock.org/ecosystems/files/Winrock_Sampling_Calculator.xls)

#### INFO

6) Wenger KF (ed.) (1984) Forestry handbook, 2nd edition. John Wiley and Sons

#### INFO

7) Gibbs KH, Brown S, Niles OJ, Foley AJ (2007) Monitoring and estimating tropical forest carbon stocks: making REDD a reality. Environ. Res. Lett. 2: 045023

## Measurement of permanent sample plots

The preceding Recipe is

Recipe P10 permanent sample plot method

As suggested by the name, permanent sample plots (PSPs) are measured periodically over a long period of time. In this recipe, permanent sample plot design (e.g., size and shape), how to conduct a tree census, and ways of improving measurement accuracy are described.

### INFO

1) Although the practice of advanced nations is the mainstream, Tomppo et al. (2010) summarizes the methodology used for national forest inventories by country.

### Plot size

The larger the area of each permanent sample plot, the larger the number of trees that must be measured, and the larger the time and expense required for the measurement. On the other hand, if the area of each permanent sample plot is small, measurement requires relatively little time and expense, but the error in the carbon stock measurement result increases. Moreover, plot area should be chosen with reference to the national forest inventory <sup>1)</sup> if one has been carried out in the past in the country, and after researching the forest structure and other characteristics of the forest. As a rough standard, an area of 0.1–0.5 ha is often used.

### Plot shape

In general, permanent sample plots are either circular or rectangular-shaped, plots are often used (Figure T13-1). Each shape has advantages and disadvantages with respect to both set-up and use. For example, the existence and location of a plot is marked with stakes. For a circular plot, a stake is required only at the central point, but it may be difficult to judge whether individual trees near the plot boundary are within the plot and

therefore should be a measurement object. On the other hand, a rectangular plot requires a stake in each of the four corners, at least, but ascertaining whether a tree should be measured is easy, because the boundary is a straight line. Moreover, because measurements will be carried out again and again, a rectangular plot has the advantage that it is easy to locate, because there are at least four stakes.

Stakes should be driven into the ground as deeply as possible so that they will not be easily dislodged by soil movement or animal activities. Moreover, in case a fire should occur, it is desirable to make the stakes out of a fireproof material such as concrete (Figure T13-2).

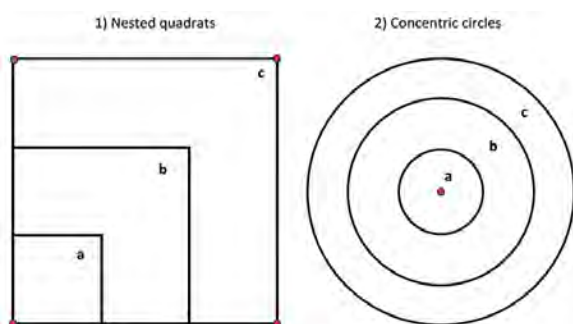

Figure T13-1 Shape of plot

Surveyor can measure the size of trees effectively, i.e., >5 cm in diameter at breast height within a, >10 cm within b and >20 cm within c.

It is best, however, to talk with the local person in charge of the forest area in advance of material selection, because if a valuable material is used, there is a risk of theft. In addition, when the plot is surveyed, for example by using a laser range finder and a compass, it is important to measure horizontal distances (not slope distances), so that estimations of the carbon stocks per unit area will be accurate <sup>2)</sup>.

One stake in each plot (in the case of a circular plot, the central stake) is defined as a reference point, and its position information is determined by GPS and recorded. This information is indispensable for revisits (for remeasurement) and for locating the plots on remote sensing images during later analyses.

### Preparation for a tree census

The number of established plots and their spatial distribution can also affect the estimation accuracy (see T12 for details). When monitoring over a long period of time is expected, development of a measurement manual can reduce measurement error caused by the measurements being performed by different people. Moreover, if periodic field investigations are planned, it is best to use tools that can be obtained locally.

The main purpose of performing a tree census in REDD-plus is to estimate carbon stocks. For this purpose, at the minimum, tree diameter at breast height (DBH), tree height (of at least some trees), and the species measured must be determined and recorded <sup>3)</sup>. These data are required by allometric equations for the calculation of biomass (see T14). Measurements of DBH and tree height are best performed by teams of at least two persons, one to do the measuring and the other to record the result. In addition, the services of an expert to identify the species measured must be secured.

Next, the minimum size of plants (excluding lianas) or trees to be measured is set: For example, only trees with a DBH of 10 cm or more might be measured. In some cases, species such as bamboo and palms may be included in the tree census, and judgments may need to be made in the field about whether marginal species with pseudo-woody stems should be considered as measurement objects.

### Raising measurement accuracy

For accurate determination of the forest structure in a plot, all living trees within the plot could be measured, but that is unrealistic with regard to time and effort. Time and effort can be saved by using a nested plot structure

#### INFO

2) In addition, the disturbance history can be investigated in the field. For example, local residents may have cut firewood or carried out selective logging. Information on land-use changes, such as the conversion of forest into rubber or oil palm plantations, is also important.



Figure T13-2 Example of stake which is resistant to disturbance (a concrete stake)

#### INFO

3) It may be necessary to measure other carbon pools, such as dead wood and soil carbon, in addition to plant biomass. See Ravindranath & Ostwald (2008) for methodologies to measure these other pools.

(e.g., concentric circles). For example, the rectangular plot shown in Figure 13-1 has three frames (a–c) whose sizes differ. This structure can reduce labor requirements by measuring in each frame trees with a different minimum DBH.

The basic measurement procedure is as follows :

- Record the position of a tree selected as a measurement object
- Assign a unique identifying number to the tree and attach a tag with that number to the tree.
- Measure the tree's diameter at breast height
- Mark the measurement height on the tree
- Identify and record the species
- Measure the tree height (when required)
- Record other pertinent information

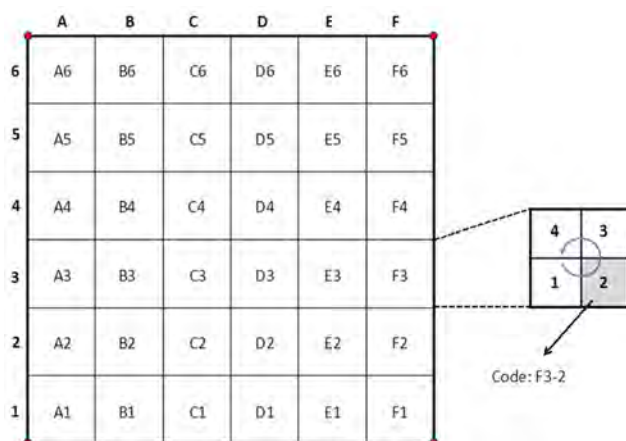

Figure T13-3 Example of compartment of plot  
For instance, the gray area has the code "F3-2"

The position within the plot of each tree being used as a measurement object must be accurately determined. By dividing a plot into sub-quadrats, and identifying each sub-quadrat by a code number, as shown in Figure T13-3, it is easy to record the position of individual trees on the resulting grid. Moreover, if the trees are numbered in a regular pattern, for example in a counterclockwise direction from the stake used as the starting point, it will be easy to tell if any tree has disappeared when future measurements (re-measurements) are carried out.

All individual trees designated as measurement objects must be assigned a unique number, and then the number must be engraved on a tag, such as a commercial aluminum tag <sup>4)</sup>, and attached to the tree. Because tags are sometimes lost (including removal by people making mischief), it will save time and effort when the tree is measured subsequently if the number is also written directly on the stem with paint, or if the rough position of the tree in the sub-quadrat and the sub-quadrat code are recorded along with the assigned identification number.

Tree diameter is usually measured at 1.3 m above the ground. Before measuring the diameter of an individual tree, the measurement location should be checked. If there is a swelling that would distort the true diameter, then that place should be avoided. Similar, if a climbing liana is wrapped around the tree, it should be removed before measurement. In such a situation, field annotations such as "measured without climber" and "measuring position moved to avoid swelling" should be written down

**INFO**  
4) For example, Racetrack-Shaped Aluminum Tags from Forestry Suppliers.

**INFO**  
5) For trees that have two or more trunks or a bent trunk, please refer to Condit (1997) or Ravindranath & Ostwald (2008), who show concrete examples of how to measure DBH.



immediately before they are forgotten <sup>5)</sup>. In addition, in the case of a tree growing on a slope, the diameter should be measured from the upper side, and the position of the measurement should be marked with paint for the next time (Figure T13-4).

Also, caution is required in the determination of a measurement position if the tree has buttress roots. The usual practice is determine the measurement height from a point 50 cm above the top of the buttress (Figure T13-5). Although this measurement requires that a ladder be used, it is important to make these measurements in the correct manner, or an error will be introduced into the estimation of biomass.

Caution is also required to use the correct tool for measurement of the DBH. For example, with calipers, the DBH is measured not once, but twice, with the second measurement being made at right angles to the first, and then the average value is used. If a tape measure is used, the DBH might become confused with the girth at breast height (GBH). It is important to be sure that the value recorded is the correct one. In addition, the same type of measurement tool should be used for all measurements of the same type. For example, some DBH measurements should not be made with an ordinary tape measure and others with slide calipers, or a diameter tape and an ordinary tape measure should not both be used.

In a tropical forest, it is often difficult to measure tree height, because it is hard to observe the tops of the trees. If measurement objects are selected by a sampling procedure that takes the size structure into consideration, then the height of only some individual trees needs to be measured and the tree height of unmeasured trees can be determined from a DBH–tree height curve. Also, it is important to verify the definition of tree height used, because some engineers may use commercial tree height.

For species identification, it is best to include an expert who can identify tree species in the field on the field crew. Although the list of possible species can be narrowed down to some extent during a field survey, accuracy will be higher if specimens are collected for later identification by a botanist.

### Bibliography

- Condit R (1997) Tropical Forest Census Plots. Springer-Verlag  
 Ravindranath NH, Ostwald M (2008) Carbon Inventory  
 Methods: Handbook for Greenhouse Gas Inventory, Carbon  
 Mitigation and Roundwood Production Projects. Springer-  
 Verlag  
 Tomppo E, Gschwantner M, Lawrence M, McRoberts RE (2010)  
 National Forest Inventories. Springer-Verlag



Figure T13-4 Clarification of measuring height (a case in Indonesia)



Figure T13-5 Measurement of diameter of tree with buttress root

Surveyor must measure the diameter at the lowest height without buttress root (solid line) rather than the diameter at breast height (1.3 m, dotted line).

## Analysis of permanent sample plot data

The preceding Recipe is

Recipe P10 permanent sample plot method

The carbon stocks in a forest are generally considered to be half the forest biomass. Therefore, to determine forest carbon stocks, the forest biomass is first estimated, often by using allometric equations. In this recipe, biomass estimation using tree census data obtained from a permanent sample plot as explained in T12 and T13 is described.

### INFO

1) In addition, if necessary, an allometric equation can be selected on the basis of the forest classification (e.g., lowland forest, montane forest, shrubland, secondary forest), the growth environment, or the succession stage.

### INFO

2) Cairns et al. (1997) and Mokany et al. (2006) have proposed generic equations for below-ground biomass. These equations use above-ground biomass (t/ha) as an independent variable, and the estimated result is also biomass per hectare (t/ha). In addition, the Hozumi equation is available for tropical evergreen and tropical seasonal forests (Hozumi et al. 1969) and the Niiyama equation can be used for dipterocarp forests in tropical lowlands (Niiyama et al. 2010) for estimation of below-ground biomass on an individual tree level.

## About allometric equations

Trees of a certain type grow in a predictable manner and the sizes of the different parts of a tree are proportionate. As a result, the size of a part that is difficult to measure can be estimated from the size of another part that is more easily measured. Scaling equations that relate the sizes of different parts of a tree are called allometric equations.

Because allometric equations reflect plant growth characteristics, the estimated results vary greatly with the forest type or the growth environment (Figure T14-1). Therefore, it is important to choose an allometric equation that is suitable for the environmental conditions in the region and the forest type (e.g., evergreen or deciduous) <sup>1)</sup>. Many equations for estimating above-ground biomass (AGB) have been proposed, and data for estimation of below-ground biomass (BGB) are also being collected <sup>2)</sup>.

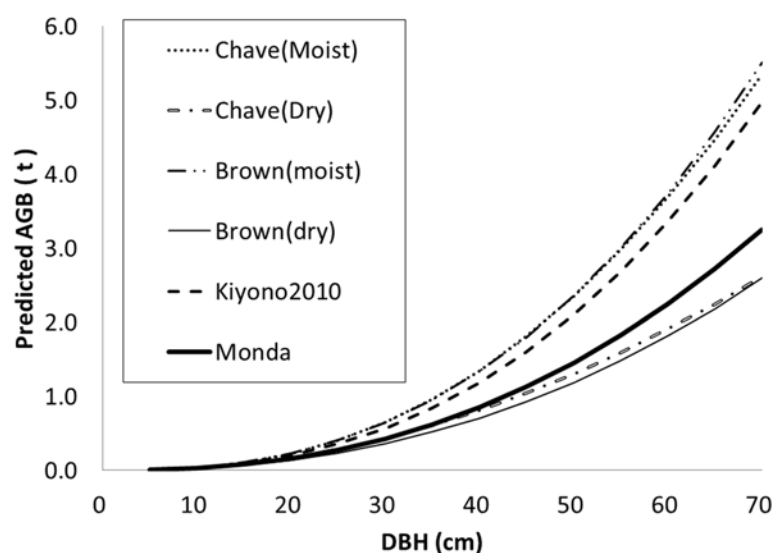

Figure T14-1 Comparison of above-ground biomass (AGB) estimations made by using different allometric equations with tree diameter at breast height (DBH).

A wood density of  $0.57 \text{ t/m}^3$ , which is the FAO default value for tropical tree species in Asia, was used to calculate the AGB. The different estimation models are described and compared in Figure T14-2

## Selection of an allometric equation suitable for the target region

An equation that relates a trait (see T13) that can be measured easily and repeatedly in the field to, for example, AGB, is selected from equations developed for use in a forest in a similar environment or of the same forest type <sup>3)</sup> (Figure T14-2). At present, various equations, both generic equations (or models) and models developed for specific localities have been developed for every forest type by using data from trees around the world <sup>4)</sup>. Many local models are species-specific or specific to a local forest stand in a specific landscape. Each has advantages and disadvantages (Table T14-1).

An allometric equation should be selected from among equations suitable for the forest type and region. If two or more applicable allometric equations are available, then information about tree size (e.g., diameter at breast height (DBH) and tree height) and dominant species in the target forest should be used with each equation and the results should be compared with available biomass data for the target forest (e.g., reported in the literature) to evaluate the estimation error of each. If there is a correlation between the estimation error and the DBH, that is an indication that the allometric relationship assumed in the equation differs from that in the target forest. In this case, as big the error of overestimation and underestimation anyway as large diameter tree arises. If no suitable equation is available, the biomass in the target area should be measured to create a suitable allometric equation. On the other hand, if the variation within error is large but no correlation exists between the estimated error and the DBH, the reason is probably that different forest types are intermingled in the target area. In this case, the classification into forest types based on species or site conditions should be re-examined, and further subdivision or stratification may be necessary. Moreover, if the estimation error is large for only a certain species, then that species probably has a different life history (e.g., it may be lower canopy tree), or the allometric relationship may differ from the usual one because that species has a unique DBH:height ratio (e.g., baobab). When

such species are abundant in a forest, their influence on the forest biomass will also be large. Therefore, a different equation should be used for trees of that species. However, if that is not considered cost effective, the error may be unavoidable.

Examples of the estimation of biomass per unit area from permanent sample plot data and the calculation of forest biomass and carbon stocks at the national level are available for Cambodia <sup>5)</sup> and Papua New

### INFO

3) Many estimation equations include wood density ( $t/m^3$ ) as an independent variable. Wood density is the weight per unit volume of the trunk. The biomass is estimated by multiplying the wood density by the volume calculated from the DBH, obtained from the tree census. Note that WD may be reported with units of  $kg/m^3$  instead of  $t/m^3$ . Wood density values at the species or genus level have been reported by the IPCC (2003, 2006) and in various papers. In tropical forests, species identification is often difficult. If the species cannot be identified, default values (Asia 0.57, America 0.60, Africa 0.58 in tropical countries) (e.g., Brown, 1997) can be used. Moreover, some papers report wood density of parts other than the trunk.

### INFO

4) Typical generic equations have been proposed by Brown (1997) and Chave et al. (2005). The basal area ( $ba: cm^2$ ) is used in the Brown equation; and wood density and DBH, or wood density, DBH, and tree height, are used in the Chave equation as independent variables. Both equations are used to estimate the above-ground biomass on an individual tree level.

Table T14-1 The characteristics comparison between generic model (generic equation) and local model

Contents	Generic model	Local model
Data set	Collected from a range of tropical tree species	Species-specific or landscape-specific data are collected
Applicable area	Applicable to forests of the same type as the data set. Application in many areas is possible.	Applicable to only forests with the same landscape or same species.
Estimation error	Medium in an applicable forest.	Small, if used in an applicable forest, but large otherwise.
Options for decreasing a large estimated error	The accuracy may be improved by using two independent variables (e.g., DBH and tree height)	Do not use in an inapplicable forest.

**INFO**

5) Samreth V, Chheng K, Monda Y, Kiyono Y, Toriyama J, Saito S, Saito H, Ito E (2012) Tree biomass carbon stock estimation using permanent sampling plot data in different types of seasonal forest in Cambodia. JARQ 46(2): 187-192

**INFO**

6) Fox JC, Yosi CK, Nimiago P, Oavika F, Pokana JN, Lavong K, Keenan RJ (2010) Assessment of aboveground carbon in primary and selectively harvested tropical forest in Papua New Guinea. Biotropica. 42(4): 410-419

**INFO**

7) A biomass expansion factor is a factor that converts the trunk volume into the volume of the whole tree, including branches, leaves, and roots. This factor depends on the tree species and the forest stand age.

Guinea <sup>6)</sup>. The biomass obtained by using an allometric equation is expressed as dry weight. That value is converted to carbon stocks by multiplying it by 0.5.

Since species, forest age, and forest management practices are constant in the case of a plantation, it can be assumed that tree size and growth conditions are also constant. In this case, the biomass expansion factor (*BEF*) <sup>7)</sup> can be used as follows:

$$C=[V \times WD \times BEF](1+R) \times CF$$

Here, *C* is carbon stock per unit area (t-C/ha), *V* is stand volume (m<sup>3</sup>/ha), *WD* is wood density (t/m<sup>3</sup>), *BEF* is the biomass expansion factor, and *CF* is the carbon content ratio (t-C/m<sup>3</sup>).

**Bibliography**

Cairns MA, Brown S, Helmer EH, Baumgardner GA (1997) Root biomass allocation in the world's upland forests. *Oecologia* 111: 1–11

IPCC (2003) Good practice guidance for land use, land-use change and forestry. IGES  
<http://www.ipcc-nggip.iges.or.jp/public/gpplulucf/gpplulucf.htm>

IPCC (2006) 2006 IPCC Guidelines for National Greenhouse Gas Inventories Volume 4, Agriculture, Forestry and Other Land Use

Mokany K, Raison R, Prokushkin A (2006) Critical analysis of root: shoot ratios in terrestrial biomes. *Global Change Biology* 12: 84–96

Niiyama K, Kajimoto T, Matsuura Y, Yamashita T, Matsuo N, Yashiro Y, Ripin A, Kassim AR, Noor NS (2010) Estimation of root biomass based on excavation of individual root systems in a primary dipterocarp forest in Pasoh Forest reserve, Peninsular Malaysia. *J Trop Ecol* 26: 71–284

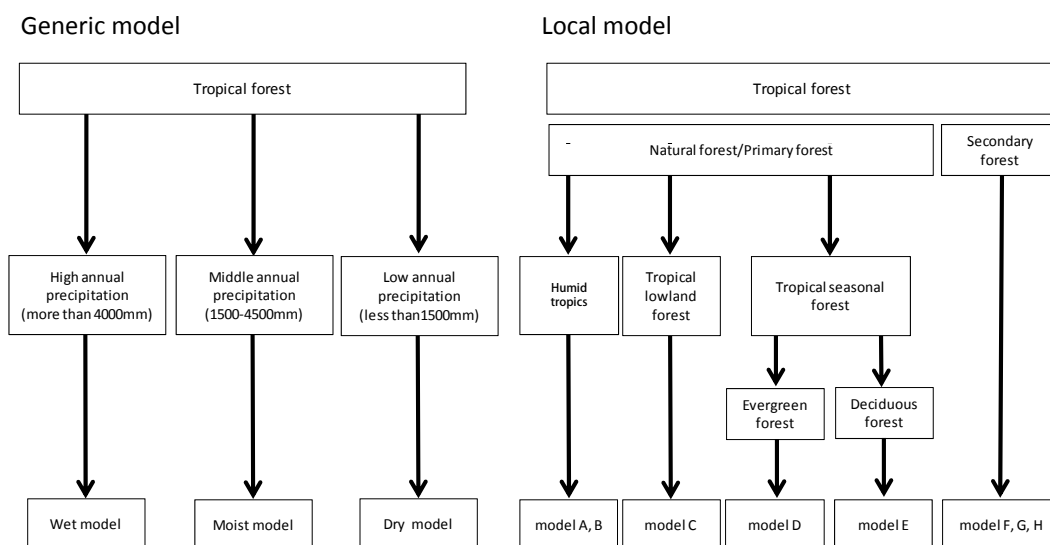

Figure T14-2 Flow for estimating allometric equation

Generic models	Allometric equation	Recommended forest type and climate condition
Brown	Wet model $AGB=21.297 - 6.953 \times DBH + 0.740 \times DBH^2$	Annual precipitation more than 4000mm. No dry season.
	Moist model $AGB=\exp(-2.134 + 2.530 \times \ln(DBH))$	Annual precipitation 1500-4500mm. No or few dry season.
	Dry model $AGB=\exp(-1.996 + 2.32 \times \ln(DBH))$	Annual precipitation less than 1500mm, several months dry season.
Chave*	Wet model $AGB=WD \times \exp(-1.302 + 1.980 \times \ln(DBH) + 0.207 \times \ln(DBH)^2 - 0.0281 \times (\ln(DBH))^3)$	Annual precipitation more than 3500mm. No dry season. High-rainfall lowland forest.
	Moist model $AGB=WD \times \exp(-1.562 + 2.148 \times \ln(DBH) + 0.207 \times \ln(DBH)^2 - 0.0281 \times (\ln(DBH))^3)$	Annual precipitation 1500-3500mm, on to 4 months dry season for lowland forests.
	Dry model $AGB=WD \times \exp(-0.730 + 1.784 \times \ln(DBH) + 0.207 \times \ln(DBH)^2 - 0.0281 \times (\ln(DBH))^3)$	Annual precipitation less than 1500mm, over 5 months dry season.
Kiyono	Moist model $Stem=2.69 \times ba^{1.29} \times WD^{1.35}$	
	Moist model $Branch=0.217 \times ba^{1.26} \times WD^{1.48}$	
	Moist model $Leaf=173 \times ba^{0.938}$	
Local models	Allometric equation	Recommended forest type
Yamakura	model A $AGB=\exp(-2.30 + 3.62 \times \ln(DBH))$	Tropical rain forest (Borneo)
Chambers	model B $AGB=\exp(-2.010 + 2.55 \times \ln(DBH))$	(Central Amazon)
Dojomo	model C $AGB=\exp(-2.05 + 2.33 \times \ln(DBH))$	Tropical lowland forest (Africa)
Hozumi	model D Stem= $0.072 \times (D^2 H)^{0.9326}$ Branch= $0.01334 \times (D^2 H)^{1.027}$ Leaf= $0.031 \times (D^2 H)^{0.7211}$	Tropical seasonal evergreen forest (Cambodia)
Monda	model E $AGB=0.3510 \times DBH^{2.3855} \times WD^{1.7827}$	Tropical seasonal deciduous forest (Indochina region)
Kenzo	model F $AGB=0.0829 \times DBH^{2.43}$	Secondary forest (Malaysia • Sarawak)
Ketterings	model G $AGB=\exp(-2.75 + 2.59 \times \ln(DBH))$	Mixed secondary forest (Indonesia • Sumatra)
Hashimoto	model H $AGB=\exp(-2.51 + 2.44 \times \ln(DBH))$	Secondary forests dominated by pioneer species (Indonesia • Eastern Kalimantan)

\*Chave has also proposed the allometric equation which uses DBH, H and WD for independent variables.

Units : Biomass (AGB, Stem, Branch, Leaf) : kg/tree, WD : t/m<sup>3</sup> (Kiyono model use kg/cm<sup>3</sup>), DBH : cm, ba : m<sup>2</sup>, D<sup>2</sup>H : DBH<sup>2</sup>(cm) × H(m)

## The sources of the flow for estimating allometric equation

- Brown S (1997) Estimating biomass and biomass change of tropical forests, a primer. FAO Forestry paper No.134. FAO, Rome
- Chambers JQ, Santos J, Ribeiro RJ, Higuchi N (2001) Tree damage, allometric relationships, and above-ground net primary production in central Amazon forest. *Forest Ecology and Management*. 152: 73-84
- Chave J, Andalo C, Brown S, Cairns MA, Chambers JQ, Eamus D, Fölster H, Fromard F, Higuchi N, Kira T, Lescure JP, Nelson BW, Ogawa H, Puig H, Réra B, Yamakura T (2005) Tree allometry and improved estimation of carbon stocks and balance in tropical forests. *Oecologia*. 145: 87-99
- Dojomo AN, Knohla A, Gravenhorst G (2010) Estimations of total ecosystem carbon pools distribution and carbon biomass current annual increment of a moist tropical forest. *Forest Ecology and Management*. 261: 1448-1459
- Hashimoto T, Tange T, M asumori M, Yagi H, Sasaki S, Kojima K (2004) Allometric equations for pioneer tree species and estimation of the aboveground biomass of a tropical secondary forest in East Kalimantan. *TROPICS*. 14(1) 123-130
- Hozumi K, Yoda K, Kokawa S, Kira T (1969) Producing ecology of tropical rain forests in southwestern Cambodia I. Plant biomass. *NATURE AND LIFE IN SOUTHEAST ASIA*. VI. 1-51
- Kenzo T, Ichie T, Hattori D, Itioka T, Handa C, Ohkubo T, Kendawang JJ, Nakamura M, Sakaguchi M, Takahashi N, Okamoto M, Tanaka-Oda A, Sakurai K, Ninomiya I (2009) Development of allometric relationships for accurate estimation of above- and below-ground biomass in tropical secondary forests in Sarawak, Malaysia. *Journal of Tropical Ecology*. 25: 371-386
- Ketterings QM, Coe R, Noordwijk M, Ambagau Y, Palm CA (2001) Reducing uncertainty in the use of allometric biomass equations for predicting above-ground tree biomass in mixed secondary forests. *Forest Ecology and Management*. 146: 199-209
- Kiyono Y, Furuya N, Sum T, Umeyama C, Ito E, Araki M, Matsumoto M (2010) Carbon stock estimation by forest measurement contributing to sustainable forest management in Cambodia. *JARQ*. 44(1): 81-92
- Yamakura T, Hagihara A, Sukardjo S, Ogawa H (1987) Tree form in a mixed Dipterocarp forest in Indonesian Borneo. *Ecological*

Figure T14-2 Flow for estimating allometric equation (cont.)

# 9

## Chapter 9 Stand carbon stock estimation models



In addition to the method of forest carbon stock estimation based on permanent sample plots (PSPs), discussed in the preceding chapter, carbon stocks can be estimated by using a model that relates a certain parameter to biomass. In this chapter, model design and evaluation, including the calculation of costs, is first explained. Subsequently, four estimation models, based on overstory height, tree crown diameter, community age, or the backscattering coefficient from SAR, are described. Because these models differ in terms of their applicability and estimation accuracy, their individual characteristics and their applicability to different forests are explained.

- T15 Model design
- T16 Overstory height method
- T17 Crown diameter method
- T18 Community age method
- T19 Backscattering coefficient method

## Model design

The preceding Recipe is

Recipe P11 Using a carbon stock estimation model

Forest carbon stocks per unit area can be indirectly estimated by using a statistical model that relates an easily measurable parameter to carbon stocks. The optimal design combines measurement of that parameter in a large sample population with direct measurement of carbon stocks in a subset of the sample population. The numbers of indirect and direct measurements can be chosen so as to minimize the measurement cost, and the efficiency of the method can be compared with that of the permanent sample plot method. This sampling design, which is called "double sampling," is introduced here as a framework for indirect forest carbon stock estimation using specific parameters. These methods are described in recipe T16–T19.

### Double sampling

In the permanent sample plot method, the mean and variance of the forest carbon stocks per unit area are estimated by direct field measurements of the carbon stocks in sampling plots permanently established in the forest (see P10 and Chapter 8). These field measurements are often costly and time-consuming, however, especially in a large forest area with limited accessibility, or they may not even be possible because of the lack of infrastructure or for security reasons. Thus, some countries have not established a network of permanent sample plots, nor do they have the capability to establish such a network in the near future.

Less costly yet accurate "double sampling" methods take advantage of models that relate forest carbon stocks to easily measurable parameters, including some that can be measured by remote sensing without requiring any field studies to be carried out on the ground.

Double sampling methods involve two stages of measurements. In the first stage, an ancillary parameter that can be measured easily and at low cost is measured in a large number of samples. The most often used parameters are overstory height (see T16), tree crown diameter (see T17), community age (see T18), and radar backscattering (see T19). In the second stage, accurate, and more costly, measurements are performed on a subset of the samples measured in the first stage. In this chapter, the second-stage measurement is assumed to be a tree census.

Double sampling methods are not always more suitable than the permanent sample plot method in terms of accuracy and cost, even if straightforward methods such as those described in T16–T19 are used. Methods being considered for the target forest should be evaluated and compared, particularly with regard to their accuracy and cost, before one is chosen for implementation. If estimates of accuracy and cost are not



available, they should be derived by examining earlier studies in similar areas or by conducting small-scale preliminary experiments.

## Indirect estimation of carbon stocks by correlation models

In the first stage, a large sample population of size  $n_1$  is selected, and an ancillary parameter,  $x$  (e.g., overstory height) is measured in that sample population. In the second stage, a subsample of size  $n_2 (< n_1)$  is selected from the first stage samples, and the carbon stocks ( $y$ ) are measured by a tree census. The two stage sample with regression estimators of the population mean for a single variable of interest and a single ancillary parameter is

$$\bar{y}_{tr} = \bar{y}_2 + b(\bar{x}_1 - \bar{x}_2) \quad (\text{T15-1})$$

where  $\bar{x}_1$  and  $\bar{x}_2$  are the sample-based estimates of the mean of  $x$  in the first- and second-stage samples, respectively, and  $\bar{y}_2$  is the estimate of the population mean of  $y$  from the second-stage sample,  $b$  is the regression coefficient of  $y$  on  $x$ ,  $b = \widehat{cov}(x, y) / \widehat{var}(x)$ ,  $\widehat{cov}(x, y)$  is the covariance of  $x$  and  $y$ , and  $\widehat{var}(x)$  is the variance of  $x$ . A better estimate of  $\widehat{var}(x)$  can be derived from the first-stage samples.

Thus, the variance of  $\bar{y}_{tr}$ ,  $\widehat{var}(\bar{y}_{tr})$ , is approximated as;

$$\widehat{var}(\bar{y}_{tr}) \cong \frac{\widehat{var}(y)(1 - \hat{\rho}_{xy}^2)}{n_2} + \frac{\widehat{var}(y)\hat{\rho}_{xy}^2}{n_1} \quad (\text{T15-2})$$

where  $\widehat{var}(y)$  is the variance of  $y$ ,  $\hat{\rho}_{xy}^2$  is the coefficient of determination between  $x$  and  $y$ , and  $\hat{\rho}_{xy}^2 = \widehat{cov}(x, y)^2 / (\widehat{var}(x)\widehat{var}(y))$ .

## Evaluation of model accuracy and costs

The larger the variance of the measurement, the lower the accuracy of the carbon stock estimation, and the bigger the sample size, the higher the level of accuracy, but also the higher the cost of the estimation. The optimal allocation of samples to the first and second stages can be estimated by minimizing the overall variance of the estimate (Eq. T15-2). Moreover, the cost of each model can be compared against that of the permanent sample plot method.

Suppose the measurement cost of a first-stage plot (i.e.,  $x$  measurement)

is  $c_1$  , and that of a second-stage plot (i.e.,  $y$  measurement) is  $c_2(c_2 > c_1)$  , then the total cost,  $c$  , is determined as follows:

$$c = n_1c_1 + n_2c_2 \tag{T15-3}$$

In double stage sampling, when  $c_1$  and  $c_2$  are given and  $c$  is constant,  $n'_1$  and  $n'_2$  that minimize Eq. 15-2 and the total variance  $\widehat{var}'(\bar{y}_{tr})$  can be calculated as follows;

$$n'_1 = \frac{c}{c_1 + c_2 \sqrt{\frac{c_1(1 - \hat{\rho}_{xy}^2)}{c_2\hat{\rho}_{xy}^2}}}, \quad n'_2 = \frac{c}{c_1 \sqrt{\frac{c_2\hat{\rho}_{xy}^2}{c_1(1 - \hat{\rho}_{xy}^2)}} + c_2} \tag{T15-4}$$

$$\widehat{var}'(\bar{y}_{tr}) = \widehat{var}(y) \frac{\left(\sqrt{c_2(1 - \hat{\rho}_{xy}^2)} + \sqrt{c_1\hat{\rho}_{xy}^2}\right)^2}{c} \tag{T15-5}$$

In the permanent sample plot method, on the other hand,  $n_2 = c / c_2$  because  $n_1 = 0$ , and the total variance  $\widehat{var}'(\bar{y}_{tr})_{PSP}$  can be calculated as follows;

$$\widehat{var}'(\bar{y}_{tr})_{PSP} = \widehat{var}(y) \frac{c_2}{c} \tag{T15-6}$$

Comparing Eqs. T15-5 and T15-6, double sampling is more accurate than permanent plot sampling when  $\widehat{var}'(\bar{y}_{tr}) < \widehat{var}'(\bar{y}_{tr})_{PSP}$  . Thus, when  $\hat{\rho}_{xy}^2$  is given and if

$$\frac{c_2}{c_1} > \frac{(1 + \sqrt{1 - \hat{\rho}_{xy}^2})^2}{\hat{\rho}_{xy}^2} \tag{T15-7}$$

then double sampling with the model should be employed. Or, when  $c_1$  and  $c_2$  are given and if

$$\hat{\rho}_{xy}^2 > \frac{4c_1c_2}{(c_1 + c_2)^2} \tag{T15-8}$$

then double sampling should not be used.

**INFO**

1) Köhl M, Magnussen SS, Marchetti M (2006) Sampling Methods, Remote Sensing and GIS Multiresource Forest Inventory. Springer-Verlag

**Notes about applying the models to a target forest**

In large forest areas or in forests with large spatial variability,  $\hat{\rho}_{xy}^2$  values of around 0.4 are not uncommon. On the other hand,  $\hat{\rho}_{xy}^2$  larger than 0.9 is

unrealistic or even questionable <sup>1)</sup>.

Results from models using remote sensing data are sometimes unstable and poorly reproducible because of the complexity of remotely sensed data, which are influenced not only by the observation target but also by many other factors and conditions between the sensor and the object.

Because forests are complex and ancillary parameters are measured indirectly, for example, by remote sensing, the model used should be as simple as possible, and the accuracy and cost of the model should be evaluated and compared with the accuracy and cost of the permanent sample plot method.

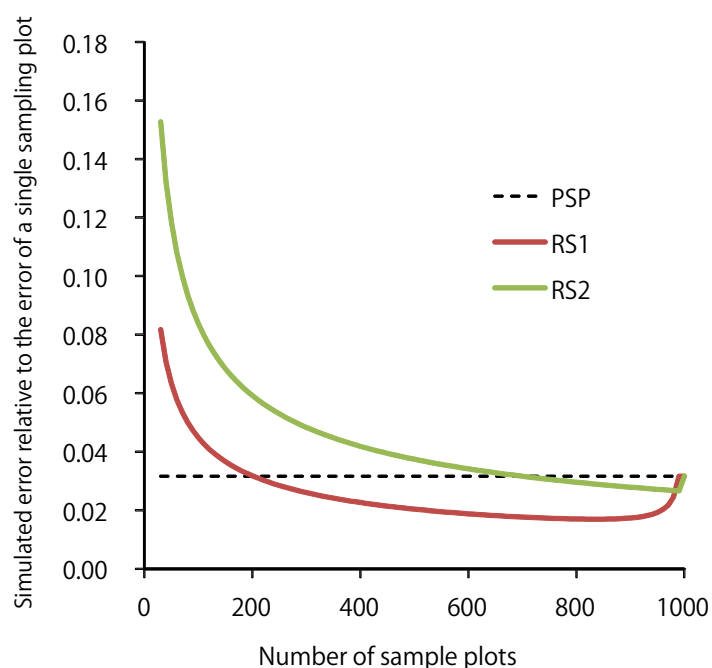

Figure T15-1 Errors by two simulated double samplings

Simulated errors of two double sampling scenarios (RS1, RS2) are plotted against the estimated error of permanent sampling plot measurements (PSP). The horizontal axis represents the number of sampling plots surveyed for the double samplings, while the vertical axis represents ratio of the total error of survey to the error of a single PSP measurement.

Suppose that the total cost available for the survey,  $c$ , is JPY10,000,000.–, and the cost of ground measurement per sampling plot,  $c_2$ , is JPY10,000.–, thus the possible number of sampling plots for PSP is 1,000, estimated error of which is plotted in the figure as a dashed line.

Further suppose that, for RS1, the cost of measurement per area of a sampling plot,  $c_1$ , is JPY100.– and the coefficient of determination between two sampling methods,  $\hat{\rho}_{xy}^2$ , is 0.8, while, for RS2,  $c_1$  is JPY1.– and  $\hat{\rho}_{xy}^2$  is 0.3.

## Overstory height method

The preceding Recipe is

Recipe P11 Using a carbon stock estimation model

Carbon stocks per unit area can be estimated from the overstory height of a forest stand on the basis of a correlation between overstory height and biomass. The method is applicable to many types of standing stock, from degraded stands with low carbon stocks to mature stands with high stocks. This recipe presents an overview of the method's underlying principles and of the challenges it poses, as well as of remote sensing techniques that can be used for overstory height estimation.

### INFO

1) There are many definitions of the overstory height in the literature (e.g., the average height of all standing trees, the average height of canopy layer trees, or a weighted average). The definition of overstory height being used must be clearly established when the model for estimation by the overstory height method is developed.

### INFO

2) Mascaro J, Asner GP, Muller-Landau HC, BreugelMv, Hall J, Dahlin K (2011) Controls over aboveground forest carbon density on Barro Colorado Island, Panama. *Biogeosciences* 8: 1615-1629

### INFO

3) Saatchi SS, Harris NL, Brown S, Lefsky M, Mitchard ETA, Salas W, Zutta BR, Buermann W, Lewis SL, Hagen S, Petrova S, White L, Silman M, Morel A (2011) Benchmark map of forest carbon stocks in tropical regions across three continents. *PNAS* 108: 9899-9904

## Correlation between overstory height and biomass

The overstory height method for estimating carbon stocks per unit area in a forest stand is based on the existence of a power-law relationship between overstory height <sup>1)</sup> and biomass (Figure T16-1). A power-law function relating the two parameters has been reported by many studies <sup>2), 3)</sup>.

For example, the carbon stocks on Barro Colorado Island, Panama <sup>2)</sup>, were estimated on the basis of a relationship between ground-based measurement of biomass and overstory height measured by airborne LiDAR. In this study, the overstory height was defined as the median height within each grid cell ranged from 30 m to 100 m widths. Another study <sup>3)</sup> estimated the carbon stocks in tropical forests across three continents at a resolution of 1 km by using space-borne LiDAR to estimate Lorey's height (i.e., the basal area-weighted height of all trees) and the correlation between Lorey's height and above-ground biomass.

These two studies demonstrated that the applicability of overstory height method depends on whether overstory height estimation by remote sensing is practical.

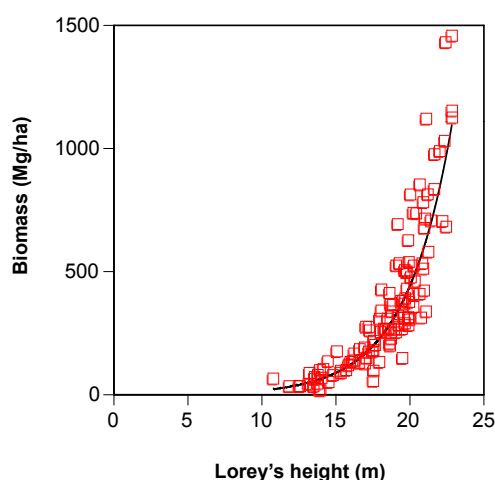

Figure T16-1 Relationship between overstory height weighted by basal area (Lorey's height) and biomass

## Measurement of overstory height by remote sensing

Airborne or satellite-borne LiDAR and stereoscopic images are remote sensing techniques that can be used to estimate overstory height.

Specifically, the overstory height is estimated by taking the difference between a digital surface model (DSM; i.e., a surface elevation map of the forest canopy) and a digital elevation model (DEM) of the ground surface derived from Airborne LiDAR data. This method can be used for forest stands with both high and low levels of carbon stocks. However, the measurement costs are relatively high. In addition, it is difficult to extrapolate from the results of one area to other areas.

ICESat/GLAS (Ice, Cloud, and Land Elevation Satellite/ Geoscience Laser Altimeter System) was a satellite-borne LiDAR system that was in operation during 2003–2010, and its data are available for free. A successor, ICESat-2, is scheduled for launch in 2016. The LiDAR pulses from ICESat were expected to strike the ground every 170 m with a footprint diameter of 70 m. Wall-to-wall satellite images can thus be combined with GLAS data to interpolate between dispersed height information on the ground <sup>4)</sup>.

Stereo pairs of aerial photographs or high-resolution satellite images <sup>5)</sup> have been used to obtain stereoscopic information about the ground surface. If a reliable digital terrain model (DTM) is available for the study area, the stereo pairs can be used to derive overstory height as well.

## Factors affecting estimation accuracy

Previous studies have suggested that, in general, the overstory height–biomass relationship does not differ significantly among forest types or succession stages <sup>1), 6)</sup>. However, the relationship for bamboo stands is significantly different from the relationships for other forest types.

The accuracy of carbon stock estimation by this method depends on the number of field measurement plots used to derive the power-law relationship between overstory height and carbon stocks (see T15). The resolution of the remote sensing data also affects the accuracy of the method.

The derived overstory height–biomass relationship depends on the allometric equation that is used to estimate the biomass. Thus, if the allometric equation is replaced with a new, more reliable one, the overstory height–biomass relationship should be recalculated.

### INFO

4) INFO 3) estimated the overstory height by maximum entropy modeling using a combination of MODIS, SRTM, and QSCAT data in addition to GLAS data.

### INFO

5) Panchromatic Remote-sensing Instrument for Stereo Mapping (PRISM) is an optical sensor on ALOS (Advanced Land Observing Satellite), which can observe the ground surface simultaneously in three directions – forward, nadir, and backward – along the satellite track. ALOS terminated operation in April 2011. Other types of high-resolution satellite imagers, e.g., Worldview and IKONOS, can provide stereo pairs of an area of interest on demand.

### INFO

6) In INFO 3), significant differences were found among the continents (SE Asia, S America, and Africa), but no significant differences were found among forest types within a continent.

## Crown diameter method

The preceding Recipe is

Recipe P11 Using a carbon stock estimation model

In the crown diameter method, carbon stocks per unit area are estimated by measuring tree crown diameters on aerial photographs or on high-resolution satellite images and then using those values to estimate tree biomass, because the biomass of each individual tree increases as its crown size (diameter and area) increases. To estimate the carbon stocks per unit area, the estimated biomass of the individual trees determined by measuring the crown diameter of every single tree could be summed, but it is impossible to directly observe the tree crowns of the middle and lower layers of a multilayer forest stand. Therefore, a method of estimating the carbon stocks per unit area in all trees, including the middle and lower layer trees, from the tree crown size of the measurable upper layer trees is needed. One of the requirements of the method, is that the individual tree crowns must be visible. Therefore, the method is most suitable for a forest consisting of trees with large crowns such as an open forest, whereas it is unsuitable for young secondary forests or bamboo forests.

### INFO

1) In this recipe, tree crown diameter is used as shorthand for tree crown size (i.e., both diameter and area).

### INFO

2) Kiyono Y, Saito S, Takahashi T, Toriyama J, Awaya Y, Asai H, Furuya N, Ochiai Y, Inoue Y, Sato T, Sophal C, Sam P, Tith B, Ito E, Siregar CA, Matsumoto M (2011) Practicalities of non-destructive methodologies in monitoring anthropogenic greenhouse gas emissions from tropical forests under the influence of human intervention. *JARQ* 45(2): 233-242

### INFO

3) In addition, the measurement of tree crown diameters is influenced by the availability of color information, the data acquisition time, and whether a stereo pair of images which makes it easier to discriminate tree stratum and adjacent tree crowns using height information available.

### INFO

4) Broadbent EN, Asner GP, Marielos Peña-Claros, Palace M, Soriano M (2008) Spatial partitioning of biomass and biodiversity in a lowland Bolivian forest: Linking field and remote sensing measurement. *For Ecol Manage* 255: 2602-2616

## Measuring tree crown diameters for estimation of carbon stocks <sup>1)</sup>

Although the biomass of an individual tree increases predictably with the tree crown size (diameter and area) <sup>2)</sup> (Figure T17-1), the measurable diameter of a tree crown depends on the ground resolution of the remote sensing imagery being used. The crown diameter of an upper layer tree can be measured on an aerial photograph or a satellite image with high ground resolution <sup>3)</sup> (Figure T17-2), and then the diameter information is converted to an index value that is used to estimate the forest carbon stocks.

A measurable tree crown is a tree crown located in the upper layer. The tree crown diameters of middle and lower layer trees cannot be measured directly because they are wholly or partially obscured by the upper layer trees, nor can the small tree crowns in a young secondary forest be measured. To deal with this situation, equations for estimating the carbon stocks of all of the trees, including the middle and upper layer trees that cannot be observed, directly from the tree crown diameter measurement data for the upper layer trees have been proposed <sup>4), 5)</sup>.

In addition, decreases in carbon stocks caused by selective logging of upper layer trees with large tree crown diameters can be estimated directly by measuring the tree crown diameters on the image obtained before the logging and comparing the results with the measurement results for the images obtained after the logging <sup>6)</sup>.

## Determining the relationship between tree crown diameter and biomass

It is not easy to measure the diameter of a tree crown in a forest. Therefore, for practical reasons it is desirable to derive a relationship between tree crown diameter measured on a remotely sensed image and biomass. Because DBH (diameter at breast height) – tree height curves generally differ among forest types, the relationship between tree crown diameter and biomass should be derived for every forest type.

The forest may be stratified by forest types and by the succession stage of forest stands. Therefore, the forest should be classified by forest type before the crown diameter method is implemented. In addition, the amount of dead wood should be estimated separately by using long-term observational data from permanent sample plots.

## Notes on the use of the crown diameter method

The crown diameter method is suitable for a forest consisting mainly of large trees with large crowns such as an open forest, whereas it is unsuitable for young secondary forests or bamboo forests. Because a tree crown is a three-dimensional structure, it is best to measure the tree crown diameter by a three-dimensional measurement technique on a stereo pair of images or to make precise orthogeometric corrections<sup>7)</sup>.

The crown of a tall tree might become damaged by lightning or wind during a storm. In this case, the biomass of the tree determined from the diameter of its crown would be underestimated. On the other hand, a group of two or more tree crowns might be interpreted as a single tree crown, which would lead to an overestimation of biomass. Conversely, branches belonging to a single tree crown might be mistaken for two or more trees, which would cause underestimation. Errors from these causes together constitute the estimation error factor<sup>8)</sup>. It is difficult to distinguish trees that have died a natural death from selectively cut trees on a remotely sensed image, although there may be clues that make it possible to infer that selective logging has taken place<sup>9)</sup>. The felling of trees for firewood or charcoal in the middle and lower layers, however, is undetectable.

Because high-resolution remote sensing data are needed for the crown diameter method, the measurement cost may be large. On the other hand, spatial differences in carbon stocks can be determined even in areas where ground access or measurement at many points is difficult.

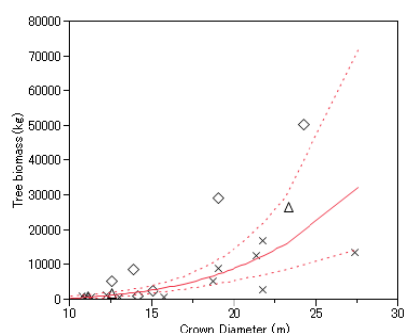

Figure T17-1 Relationship between crown diameter and single tree biomass (Modified from Kiyono et al. 2)  
 (◇ : Kalimantan, Indonesia  
 △ : Cambodia, × : Java, Indonesia)



Figure T17-2 Extraction of crown polygon by stereoscopy of digital aerial photograph (dry dipterocarp forest in Kampong Thom, Cambodia)

### INFO

5) In general, the ratio of the whole upper tree biomass is high. Moreover, the crown diameter of upper level trees is used as an index of the developmental stage of a stand structure.

### INFO

6) See, for example, Win RN, Suzuki R, Takeda S (2012) Remote sensing analysis of forest damage by selection logging in the Kabaung Reserved Forest, Bago Mountains, Myanmar. *J For Res* 17: 121-128

### INFO

7) Many commercial satellites carrying high-resolution sensors have a feature called a pointing function that allows angled observations, thus increasing the observation field. Because of distortions due to the observation angle, however, tree crown diameters at the edges of such images cannot be accurately measured, even if orthogeometric corrections are made by referring to a precise digital elevation model. Tree crown diameters in the central part of such images (obtained when the sensor is pointing directly below the aircraft in the case of aerial photos or by using a small pointing angle in the case of satellite images) can be measured accurately.

### INFO

8) In addition, although wood density (wood specific gravity) also influences biomass estimation, it is technically difficult to identify species on remote sensing images at present. For simplicity, therefore, timber volume density is set to a constant value or it is set according to the forest type.

### INFO

9) Selective logging may be indicated by detection of areas where many trees have been logged, or by identifying tracks, along which logs have been dragged.

## Community age method

The preceding Recipe is

Recipe P11 Using a carbon stock estimation model

If the forest was cleared in the past and the vegetation is in the process of recovery, community age can be used as an index value for estimation of carbon stocks. Here, community age method for carbon stock estimation is outlined and the circumstances under which it may be applicable are described.

### INFO

1) The number of years after harvest, i.e., the number of fallow years, is used as the index value in slash-and-burn agriculture.

### INFO

2) Inoue Y, Qi J, Olioso A, Kiyono Y, Ochiai Y, Horie T, Asai H, Saito K, Shiraiwa T, Douangsavanh L (2007) Traceability of slash-and-burn land-use history using optical satellite sensor imagery: a basis for chronological assessment of ecosystem carbon stock in Laos. *Int J Rem Sens* 28: 5641-5648

### INFO

3) Inoue Y, Kiyono Y, Asai H, Ochiai Y, Qi J, Olioso A, Shiraiwa T, Horie T, Saito K, Douangsavanh L (2010) Assessing land-use and carbon stock in slash-and-burn ecosystems in tropical mountain of Laos based on time-series satellite images. *Int J Appl Earth Obs Geoinf* 12: 287-297

## About the community age method

Where slash-and-burn agriculture is practiced, for example, land is cleared when the crops are harvested and then the natural vegetation is allowed to gradually recover. Land may also be cleared to establish a plantation of a perennial crop such as rubber or oil palm or a forest plantation. In each case, the vegetation community, whether it consists of natural vegetation or plantation trees, has a uniform age, and it is possible to estimate the carbon stocks of the ecosystem by using community age <sup>1)</sup> in regions where such land uses are practiced.

Moreover, because the area of each community age can be determined from a time series of satellite images <sup>2)</sup>, the carbon stocks in those areas can be calculated by multiplying the total area by the carbon stocks per unit area determined by the community age method <sup>3)</sup>. In addition, the method can be used to estimate forest degradation resulting from, for example, a reduction of the fallow period in slash-and-burn agricultural systems, or carbon stock changes caused by the conversion of natural forest to rubber or oil palm plantations <sup>3)</sup>.

## Creation of the relational equation by field survey

The relationship between carbon stocks and the number of fallow years during which the forest is allowed to recover after the harvest in slash-and-burn agriculture has been determined empirically in northern Laos and northern Vietnam <sup>4)</sup>. These recovery curves show a rapid increase in carbon stocks in first few years, after which the increase slows and eventually plateaus (Figure T18-1).

To estimate carbon stocks by the community age method, the carbon stocks in communities of different ages must be determined by a field survey, and then the data can be used to create a relational expression.

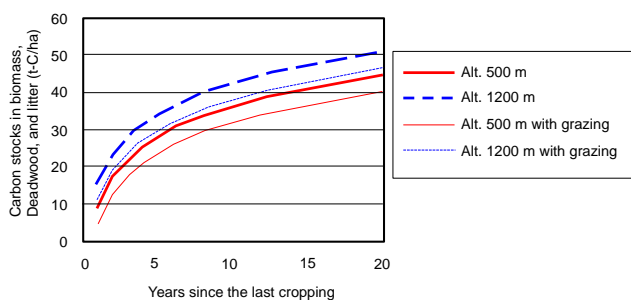

Figure T18-1 Relationship between the years since the last cropping and the ecosystem carbon stocks (Modified from Kiyono et al. 2007)



To accomplish this, sampling plots in areas with vegetation of uniform and known age should be established. Then, in a plot in which herbaceous plants are dominant, just after clearing, the plants can be cut and weighed <sup>5)</sup>, <sup>6)</sup> and then their weight can be converted into carbon stocks. In plots in which woody plants have become established, carbon stocks can be estimated by a tree census.

The rate of recovery of vegetation after crops are harvested in slash-and-burn agriculture may differ under different environmental conditions (e.g., disturbances during recovery or elevation differences). For example, the recovery of carbon stocks after harvest in northern Laos depends on whether livestock are grazed on the land during the fallow period and on whether the site is in the lowlands or in the mountains <sup>2)</sup> (Figure T18-1). Factors such as these need to be taken into consideration when a relational equation is developed, and information about them should be collected to improve estimation accuracy.

### Advantages and disadvantages of the community age method

This technique is applicable where management of land is local, and where unexpected vegetation changes seldom occur. It is particularly applicable where land use is rotated at fixed intervals, so that a mosaic of communities of different ages exists (Figure T18-2). Under these conditions, the field data that are needed to develop the relational equation can be acquired comparatively easily. It is important to know exactly when each land parcel was cleared, so monitoring at least once for a year for that purpose is necessary.

If the community age method is to be applied in a large area (e.g., at the national or sub-national level), two or more relational expressions will be needed that take into account different uses of the land after harvest (slash-and-burn agriculture) and species differences among plantations. Another disadvantage is that the felling of trees in the target area or the collection of firewood cannot be detected by the community age method. If either of these commonly occur, their impact on the carbon stocks needs to be determined by a separate investigation.

### Bibliography

Condit R (1997) Tropical Forest Census Plots. Springer-Verlag

#### INFO

4) Do TV, Osawa A, Thang NT (2010) Recovery process of a mountain forest after shifting cultivation in Northwestern Vietnam. *For. Ecol. Manage.* 259: 1650-1659

#### INFO

5) The biomass of all herbaceous plants growing in a plot of a certain size (e.g., 1 m<sup>2</sup>) is determined by cutting the plants at ground level and determining their total dry weight. This technique is mainly used to determine biomass in grasslands.

#### INFO

6) Mannerje L.'t (2000) Measuring biomass of grassland vegetation. In: *Field and Laboratory Methods for Grassland and Animal Production Research*. Mannerje L.'t, Jones RM (ed.) CABI Publishing Univ Press, Cambridge, 151-177



Figure T18-2 Slash-and-burn agricultural fallows in a mosaic-like pattern of different fallow ages in northern Laos (Photo taken by Naoyuki Furuya)

## Backscattering coefficient method

The preceding Recipe is

Recipe P11 Using a carbon stock estimation model

Satellite-borne Synthetic Aperture Radar (SAR) is a technology of remote sensing which can observe the surface of the earth even when the surface is obscured by clouds. The backscattering coefficient <sup>1)</sup> of the reflected radiation observed by SAR is correlated with above-ground biomass up to a total biomass of about 100 t/ha, although above that value saturation occurs. Thus, by modeling the relationship between the backscattering coefficient and biomass, the carbon stocks can be measured in, for example, forests where a large disturbance has occurred and the forest is still in an early stage of succession, such as recovery after slash-and-burn. Here, the backscattering coefficient method is outlined and the limits of its application are described.

### INFO

1) The received digital number (sigma-naught) or a corrected value, where the dependence on the incidence angle has been rectified by geographic correction (gamma-naught), can be used as the backscattering coefficient <sup>2)</sup>.

### INFO

2) Shimada M (2010) Ortho-rectification and slope correction of SAR data using DEM and its accuracy evaluation. IEEE J Select Topic Appl Earth Obs Remo Sens 3(4): 657-671

### INFO

3) Lucas RM, Cronin N, Lee A, Moghaddam M, Witte C, Tickle P (2006) Empirical relationships between AIRSAR backscatter and LiDAR-derived forest biomass, Queensland, Australia. Rem Sens Environ 100: 407-425

### INFO

4) Roy J, Saugier B, Mooney, HA (2001) Terrestrial Global Productivity. Academic Press.

### About the backscattering coefficient method

SAR is an active sensor which transmits microwave pulses to the earth's surface then detect the reflected pulses back from the earth's surface. The backscattering coefficient is derived from the reflected signals <sup>2)</sup>. The correlation between the backscattering coefficient and biomass is high for long-wavelength (L band, about 23 cm), but saturation occurs at a biomass of about 100 t/ha <sup>3)</sup>. For comparison, the above-ground biomass of a mature tropical forest can be as high as 400–500 t/ha and usually exceeds 200 t/ha <sup>4)</sup>.

For this reason, it is difficult to estimate the biomass of a mature forest. The method is suitable, however, for mapping biomass changes over a large area of forest that is recovering from some kind of large-scale disturbance (e.g., slash-and-burn or plantation agriculture). In hilly terrain, topographic distortion should be corrected.

### Creation of the estimation model by field survey

The backscattering coefficient initially increases rapidly as biomass increases, and then the increase slows gradually until saturation occurs. Thus, the relationship between the backscattering coefficient and biomass can be approximated by an exponential function <sup>3)</sup> (Figure T19-1). The saturation level is reached sooner with like-polarized waves (HH, VV) than with cross-polarized (HV, VH) waves. The relational expression (model) is created by collecting biomass data in the field, converting them to carbon stocks, and then comparing the results with backscattering coefficients from the same area. To obtain high-precision biomass estimates, the field data should be obtained from forest stands with various biomass. It is particularly important to collect data from low-biomass stands. Although the estimation model

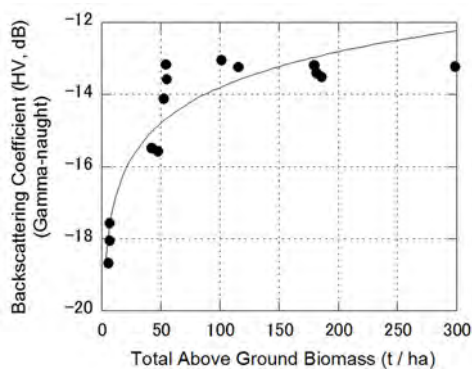

may depend on the forest type, the model should be applicable to two or more satellite scenes, because the change in the backscattering coefficient caused by seasonal differences is small in closed tropical rain forests.

Figure T19-1 Relationship between backscattering coefficient and total above-ground biomass

### An example of biomass estimation

Figure T19-2 illustrates biomass estimation by the backscattering coefficient method in a peat bog forest in central Kalimantan, Indonesia. The biomass is about 300 t/ha and saturation of the backscattering coefficient is reached in the natural forest in this area. In an open forest in which the forest floor is covered by standing water (a bog), after the SAR electromagnetic pulses reflect off the water surface, they may reflect off the trunk of a tree or another object, before being reflected back to the SAR sensor. This is called a double bounce, and can cause overestimation of the biomass. Bias of the

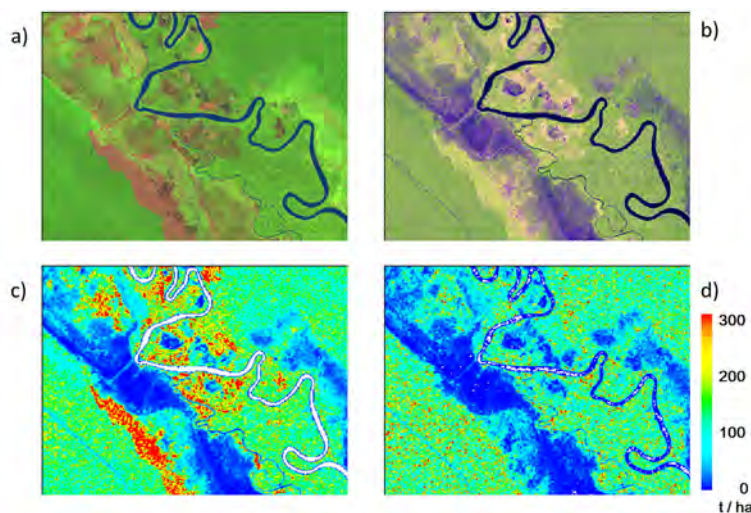

Figure T19-2 Estimated distribution of the above-ground biomass by the backscattering coefficient method

a) Study area by Landsat 7 ETM+ image, August, 2007, b) Study area by ALOS/PALSAR, October, 2007, c) Estimated distribution of the above-ground biomass, d) Improved estimation by correcting effects from the double bounce.

Forests are colored green in both a) and b), while burnt areas and sparse swamp forests are colored beige in b). Overestimation of biomass due to the double bounce c) is reduced by the correction d).

ALOS/PALSAR: © JAXA, METI

double bounce can be eliminated by using dual polarization as indicated in Figure T19-2.

### Advantages and disadvantages of the backscattering coefficient method

Since L-band SAR penetrates clouds, data can be acquired even in an area that is cloudy for much of the year. Thus, the backscattering coefficient method is expected to be especially useful in tropical rainforests where deforestation is a big problem.

Although carbon stocks of low-biomass forests can be estimated with sufficient accuracy, the method's accuracy is low in high-biomass forests, so the results are not reliable. For this reason, the use of the method is restricted to forest in an early stage of succession, or it can be used to monitor an area that has been clear-cut.

Excessive noise, called speckle noise, occurs irregularly in SAR data. This noise can be reduced by averaging the values across groups of neighboring pixels, instead of using per-pixel values, but the ground resolution of the measurement deteriorates as a result.

At present, topographic correction in mountainous areas is not sufficiently accurate, so the backscattering coefficient method cannot be applied to a forest on medium to steep slopes. In general, the accuracy of the biomass estimate decreases when the inclination of the slope exceeds 10° to 15°. The low accuracy of even corrected values may be caused in part by the use of elevation data with low accuracy for the correction, or it may be caused by using a correction model that cannot account for the scattering by the crowns of trees growing on slopes. In the future, these problems may be solved, thus allowing the method to be used even for forests growing on a steep slope.

# Reference Guide



## 【Reference Guide】

This reference guide introduces further reading materials (reports, guidelines, manuals, papers, etc.) to help Cookbook users to deepen their understanding of recipes presented in Introduction and Planning (Chapters 1–5). Furthermore, this guide includes references that contain recommendations, suggestions and case studies relevant to each recipe, which will be of help to users who seek practical solutions for the challenges they encounter in designing and implementing projects and programs.

### Anticipated audiences

- ✓Policy makers, program developers, and their partners engaging REDD-plus activities at national/sub-national levels
- ✓REDD-plus project proponents
- ✓People who wish to expand their knowledge of REDD-plus beyond forest carbon measurement

### How to use the guide

References are introduced in the following form :

No.	Title	Language <sup>*3</sup>	Year	Lead author	Organization or publisher
Recipe <sup>*1</sup>	Overview (Here we discuss multiple aspects of each reference: e.g., objective, main points, comprehensiveness, level of detail, practical suggestions and case studies, and usefulness)				
Implementation level <sup>*2</sup>					
Source of original materials					

\*1 Related recipe in the Cookbook

\*2 Implementation level for which the reference will be most useful: international, national, sub-national, or project

\*3 Key of language. CH: Chinese, EN: English, FR: French, IN: Indonesian, JP: Japanese, PO: Portuguese, SP: Spanish, VI: Vietnamese

### Further information

Users who wish to learn more about a specific recipe should visit The REDD Research and Development Center's Reference Data Base for additional reference information.

<http://www.ffpri.affrc.go.jp/redd-rdc/en/reference/reference.html>

## Chapter 1: About REDD-plus

No. 1	Reducing Emissions from Deforestation and Forest Degradation	EN	2011	Agrawal et al.	Annual Review of Environment and Resources
I01	This review assesses trends of REDD-plus discussions mainly from a social science perspective. After introducing the history of REDD-plus negotiations and explaining environmental and social aspects of REDD-plus, it briefly reviews actors in international and national initiatives, markets, and civil society as well as problems of carbon monitoring, with the challenges of carbon monitoring as a crosscutting theme. This multi-faceted review is one of best introductions to REDD-plus.				
International, National, Sub-national, Project					
<a href="http://www.annualreviews.org/doi/abs/10.1146/annurev-environ-042009-094508">http://www.annualreviews.org/doi/abs/10.1146/annurev-environ-042009-094508</a>					

No. 2	REDD-plus (Reducing Emissions from Deforestation and Forest Degradation in developing countries; and the role of conservation, sustainable management of forests and enhancement of forest carbon stocks in developing countries)	EN JP	2012 2 <sup>nd</sup> Ed.	Japan International Cooperation Agency (JICA) International Tropical Timber Organization (ITTO)	
I01	This booklet published by JICA and ITTO is designed for the general public with the aim of raising awareness and increasing understanding of REDD-plus. In addition to a brief introduction on the context and concept of REDD-plus, it gives an overview of Japanese government policies on climate change and the involvement of JICA and ITTO in REDD-plus. This publication will be of most benefit to newcomers to REDD-plus who wish to understand the basic concept of REDD-plus and to people involved in REDD-plus who wish to get the "big picture" of ongoing REDD-plus related projects and activities implemented by JICA and ITTO.				
International, National, Subnational, Project					
<a href="http://www.jica.go.jp/publication/pamph/pdf/redd.pdf">http://www.jica.go.jp/publication/pamph/pdf/redd.pdf</a>					

No. 3	What is the right scale for REDD? The implications of national, subnational and nested approaches	EN VI	2008	Angelsen et al.	CIFOR
I02	This CIFOR brief gives a clear idea of three approaches at three levels or scales of REDD accounting and incentive mechanisms: national, sub-national or project, or a nested approach. The three approaches are briefly introduced and assessed by the three criteria of effectiveness, efficiency, and equity. Although this brief doesn't provide case studies, it is useful for understanding the concept and pro & cons of each approach in a short time. It is highly recommended, particularly for people who wish to understand the concept of linking REDD-plus projects with REDD-plus activities at national level.				
National, Sub-national, Project					
<a href="http://www.cifor.org/online-library/browse/view-publication/publication/2595.html">http://www.cifor.org/online-library/browse/view-publication/publication/2595.html</a>					

No. 4	REDD+ at project scale: Evaluation and Development Guide	EN FR	2010	Calmel et al.	FFEM, ONFI, etc.
I02	This is a guide to REDD-plus project development and project evaluation designed for project developers, investors and funding agencies. This guidebook covers a range of topics, such as site selection, design and implementation of activities, legal and institutional aspects, economic and financial aspects, and environmental and social safeguards, in a balanced manner. It also presents case studies and gives specific suggestions for each topic. This guide is highly recommended for project proponents and program/policy makers of REDD-plus.				
Project					
<a href="http://www.onfinternational.org/en/publications/313-qguide-redd-a-lechelle-projetq-guide-devaluation-et-de-developpement.html">http://www.onfinternational.org/en/publications/313-qguide-redd-a-lechelle-projetq-guide-devaluation-et-de-developpement.html</a>					

No. 5	Building Forest Carbon Projects: Step-by-Step Overview and Guide <sup>1)</sup> In: Building Forest Carbon Projects <sup>2)</sup>	EN	2011	1) Olander & Ebeling 2) Ebeling & Olander (ed.)	Forest Trends
I02 I03 I04	This series of guides helps project proponents by giving tips on making a project successful. Based on Forest Trends' experience in forest carbon projects, it covers multiple aspects of REDD-plus, including technical issues, environmental and social considerations, and financial matters. This series covers eight topics: overview, REDD technical project design, afforestation/reforestation technical project design, carbon stock assessment, community engagement, legal issues, business, social impacts, and biodiversity impacts. Each guide will be a useful reference for project proponents. These are all freely downloadable.				
Project					
<a href="http://forest-trends.org/publication_details.php?publicationID=2555">http://forest-trends.org/publication_details.php?publicationID=2555</a>					



## Chapter 2: Designing a forest monitoring system

No. 6	Cost of implementing methodologies and monitoring systems relating to estimates of emissions from deforestation and forest degradation, the assessment of carbon stocks and greenhouse gas emissions from changes in forest cover, and the enhancement of carbon stocks. Technical paper ( FCCC/TP/2009/1)	EN	2009	UNFCCC
102 103	This technical paper prepared by the UNFCCC secretariat gives an overview of the requirements, steps, and cost of developing and implementing a GHG monitoring system. It contains information on the current state of monitoring capacity of non-Annex I countries and the required capacity for implementing the system, cost estimation by country, by each step of system development and by each country's land area, and the relationship between cost and accuracy and precision. This report also present a case study of development of the Indian national forest monitoring system as well as further references to studies conducting detailed cost analyses of the development. For people in charge of a national forest monitoring system for REDD-plus and for those who wish to follow this topic, this paper is a useful introduction.			
National				
<a href="http://unfccc.int/documentation/documents/advanced_search/items/6911.php?priref=600005151">http://unfccc.int/documentation/documents/advanced_search/items/6911.php?priref=600005151</a>				

No. 7	An assessment of national forest monitoring capabilities in tropical non-Annex I countries: Recommendations for capacity building	EN	2009	Herold	GOFC-GOLD Project Office
103	This study aims to identify, for 99 tropical non-Annex I countries, the near-term capacity-development activities that are necessary for implementing a forest area change and carbon stock monitoring system. Readers get an overview of the status of forest monitoring system development in 99 countries and the challenges they face. In addition, the study provides detailed country reports on current capacity and suggestions on further capacity development for 30 of those countries. The study will be of most benefit to project managers who wish to understand the status of forest carbon monitoring systems in the countries of their interest.				
International, National					
<a href="http://unfccc.int/methods_science/redd/methodologies/other/items/4542.php">http://unfccc.int/methods_science/redd/methodologies/other/items/4542.php</a>					

No. 8	Estimating the cost of building capacity in rainforest nations to allow them to participate in a global REDD mechanism	EN	2008	Hoare et al.	Chatham House
I04	This report estimates funds required for 'readiness' activities needed for 25 rainforest countries to participate in a REDD mechanism. It calculates the costs of concrete activities such as developing a national REDD strategy, development of reference levels & forest inventory, land use planning & zoning, and forest policy & legislation and reform. Annex 1 gives project case studies and their costs, surveyed for this report. This report will be of most benefit to policy makers or donors as a reference on the funds necessary for readiness, as well as a catalog of case studies.				
International, National					
<a href="http://www.illegal-logging.info/item_single.php?it_id=744&amp;it=document">http://www.illegal-logging.info/item_single.php?it_id=744&amp;it=document</a>					

No. 9	A stepwise framework for developing REDD+ reference levels. In: <i>Analysing REDD+ Challenges and Choices</i>	EN	2012	Herold et al.	CIFOR
I04 P13	This chapter in the CIFOR book <i>Analysing REDD+ Challenges and Choices</i> introduces a stepwise approach necessary for developing forest reference (emission) levels. It explains a three-step approach and the different technical capacities required by each step, and points out problems of uncertainty and different ways of coping with it. This chapter also contains case studies from Brazil, Indonesia and Viet Nam in which multiple regression analyses are applied (Step Two). In addition, Box 16.3 is very useful for people who are confused about REDD-plus terminology and the differences between 'three phases', 'three approaches', 'three tiers' and 'three steps'!				
National, Sub-national, Project					
<a href="http://www.cifor.org/online-library/browse/view-publication/publication/3805.html">http://www.cifor.org/online-library/browse/view-publication/publication/3805.html</a>					

No. 10	What is needed to make REDD+ work on the ground? Lessons learned from pilot forest carbon initiatives	EN SP PO FR CH	2010	Harvey et al.	Conservation International
I04	This report provides a summary of the key factors needed to ensure that REDD-plus projects are successful at reducing greenhouse gas emissions, while also providing biodiversity and social co-benefits. It is based on the initial experiences of 12 forest carbon projects (5 REDD-plus and 7 AR/CDM). The reports highlight five key factors for success: 1) strong partnerships and local capacity; 2) robust technical and scientific information and analysis; 3) sufficient funding for project development 4) strong stakeholder participation both in project design and implementation; and 5) full support from the government. The report provides an overview of how the 12 forest carbon projects were designed and implemented, and includes a summary of the key lessons learned. It also provides recommendations on how to ensure forest carbon projects provide the desired climate, biodiversity and social benefits. The report will be of most benefit to project managers who are initiating feasibility studies.				
Project					
<a href="http://www.conservation.org/publications/Pages/REDD_lessons_learned.aspx">http://www.conservation.org/publications/Pages/REDD_lessons_learned.aspx</a>					

### Chapter 3: Basic knowledge for REDD-plus implementation

No. 11	Legal Frameworks for REDD : Design and Implementation at the National Level	EN	2009	Costenbader (ed.)	IUCN
I04 P03	This IUCN report on legal frameworks for REDD presents the legal requirements that need to be addressed at national level (such as ownership of land, use rights, participation, benefit sharing, additionally, and permanence) and makes suggestions about framework development. As appendices, it includes a checklist of these requirements and examples of REDD-plus legal frameworks from four countries (Brazil, Cameroon, Guiana, and Papua New Guinea), which have been carefully chosen by considering geographic condition, forest area, deforestation rate, etc. This report will be useful for policymakers and project proponents who wish to investigate topics that should be considered in developing the legal framework in their own country.				
National, Sub-national, Project					
<a href="http://www.iucn.org/about/work/programmes/environmental_law/elp_resources/elp_res_publications/?uPubsID=3943">http://www.iucn.org/about/work/programmes/environmental_law/elp_resources/elp_res_publications/?uPubsID=3943</a>					

No. 12	The Importance of Defining 'Forest': Tropical Forest Degradation, Deforestation, Long-term Phase Shifts, and Further Transitions	EN	2010	Putz & Redford	Biotropica Vol 42 Issue 1
P01	This paper is a comprehensive discussion about the history of the term 'forest' and its use by diverse actors in the social and natural sciences. The paper includes discussion of 'forest' as defined by the UNFCCC and FAO, and of the definitions 'deforestation' and 'forest degradation' in tropical regions used for REDD-plus. This paper is particularly useful for REDD-plus negotiators and scholars who are interested in REDD-plus issues and who wish to understand the definitions used in REDD-plus discussions and the problems with those definitions.				
International, National					
<a href="http://onlinelibrary.wiley.com/doi/10.1111/j.1744-7429.2009.00567.x/abstract">http://onlinelibrary.wiley.com/doi/10.1111/j.1744-7429.2009.00567.x/abstract</a>					

No. 13	Global and national REDD+ architecture Linking institutions and actions. In: Realising REDD+ National Strategy and Policy Options	EN IN SP FR	2009	Wertz- Kanounnikoff & Angelsen	CIFOR
P01	The one of topics of this chapter, in a CIFOR book entitled <i>Realising REDD+ National Strategy and Policy</i> , is a discussion of the '-plus' of REDD. The chapter briefly outlines the history on of the negotiations and how 'RED' evolved to 'REDD-plus'. In addition, Box 1.1 in Chapter 1 of this book summarizes the definition of REDD-plus. These parts of the book will be useful for newcomers to REDD-plus or people who wish to revisit the discussion about the definition of REDD-plus.				
International					
<a href="http://www.cifor.org/online-library/browse/view-publication/publication/2871.html">http://www.cifor.org/online-library/browse/view-publication/publication/2871.html</a>					

No. 14	(A) REDD+ Institutional Options Assessment (Chapter 2) (B) Reducing Emissions from Deforestation and Forest Degradation (REDD): An Options Assessment Report (Chapter 2)	EN FR SP PO	2009	(A) Streck et al. (B) Angelsen et al.	Meridian Institute
P02	These two reports (A) and (B) introduce the phased approach. Chapter 2 of report (A) summarizes the three phases. In particular, Table 2.1 is a useful introduction to specific topics such as activities, costs, performance indicators, and capacity for MRV, and an overview of the requirements of each phase. Chapter 2 of report b explains the relationship between the phased approach and finance options in detail. It describes activities that require financial support and proposes options for mobilization of international finance for each phase. We suggest people who wish to understand the basics of the phased approach to read the two chapters together.				
International, National					
<a href="http://www.redd-oar.org/rl.html">http://www.redd-oar.org/rl.html</a>					

No. 15	REDD+ safeguards in national policy discourse and pilot projects. In: Analysing REDD+ Challenges and Choices	EN	2012	Jagger et al.	CIFOR
P03	This chapter in the CIFOR book is an overview of the current state of environmental and social safeguards and highlights challenges and choices for implementing REDD-plus safeguards. This brief consists primarily of an analysis of the safeguards established in several ongoing pilot projects in Brazil, Cameroon, Indonesia, Tanzania, and Viet Nam, and also discusses core safeguard issues covered by the national media. This chapter will be useful for people such as project proponents who wish to get information necessary to understand the current UNFCCC negotiations about how safeguards for REDD-plus activities are to be addressed and respected.				
International, National, Sub-national, Project					
<a href="http://www.cifor.org/online-library/browse/view-publication/publication/3805.html">http://www.cifor.org/online-library/browse/view-publication/publication/3805.html</a>					

No. 16	Safeguarding and enhancing the ecosystem-derived benefits of REDD+ Multiple Benefits Series 2	EN	2010	Miles et al.	UNEP-WCMC, UN-REDD Programme
P03	This issue paper provides concrete ideas on how national REDD-plus programs can safeguard ecosystem services and biodiversity and proposes options for enhancing these benefits. It describes approaches and methods to enhance ecosystem services and benefits in a comprehensive manner and introduces tools available for the purpose. This paper will be particularly useful for program developers who need to incorporate the consideration of safeguards for ecosystem services and biodiversity into a REDD-plus program.				
National, Sub-national					
<a href="http://www.unep-wcmc.org/multiple-benefits-series-2_629.html">http://www.unep-wcmc.org/multiple-benefits-series-2_629.html</a>					

No. 17	Multiple Benefits Series 5 & 6 (A) Ecosystem services and biodiversity from new and restored forests: tool development (B) Methods for assessing and monitoring change in the ecosystem-derived benefits of afforestation, reforestation and forest restoration	EN	2010	(A) Miles et al. (B) Doswald et al.	UNEP-WCMC, UN-REDD Programme
P03	These two documents (A) and (B) address safeguard issues of projects and programs that include afforestation, reforestation, and forest restoration activities. Document (A) provides useful information about assessing the potential impacts of these activities on biodiversity, water, soil, and non-timber forest products by providing a visual 'score card'. It also lists many papers that can be consulted to obtain additional information. Document b summarizes the requirements and steps of designing a monitoring system to assess the impacts and introduces several guides and methods for designing such a system. The two documents together will help people who wish to understand basic approaches to avoiding adverse impacts of afforestation, reforestation, and forest restoration activities.				
National, Sub-national, Project					
<a href="http://www.un-redd.org/MultipleBenefitsPublications/tabid/5954/Default.aspx">http://www.un-redd.org/MultipleBenefitsPublications/tabid/5954/Default.aspx</a>					

No. 18	Climate Change & the Role of Forests A Trainer's Manual	EN etc.	2010	Stone et al.	Conservation International
P03	The Climate Change and the Role of Forests Training of Trainers materials are designed to expand local communities' knowledge about issues related to climate science, the forest carbon cycle, climate policy, Payment for Ecosystem Services, and REDD-plus. The main objective of these materials is to expand the number of skilled trainers who are able to effectively deliver information on issues related to climate change and REDD-plus to communities and other local stakeholders. The methodology includes guidance on training design and facilitation skills and, along with the manual, the training toolkit also includes flashcards, posters, and training activities. The materials are available in seven languages (English, Spanish, French, Bahasa (Indonesian), Malagasy, Khmer (Cambodian), and Mandarin (Chinese)) and have been used in 12 countries. The toolkit is available for not-for-profit organizations upon request.				
Project					
<a href="http://www.conservation.org/publications/Pages/climate_change_and_the_role_of_forests.aspx">http://www.conservation.org/publications/Pages/climate_change_and_the_role_of_forests.aspx</a>					

## Chapter 4: Measurement, reporting and verification (MRV) of forest carbon

No. 19	Emissions factors. Converting land use change to CO2 estimates. In: <i>Analysing REDD+ Challenges and choices</i>	EN	2012	Verchot et al.	CIFOR
P04	This chapter in <i>Analysing REDD-PLUS Challenges and Choices</i> introduces the measuring of forest carbon in REDD-plus, and describes the current state of non-Annex I countries with regard to capacity and information available for the measurement, and concludes by summarizes future challenges. It gives detailed explanations of the Gain-Loss Method (including an approach for peatland) and the Tier 1 approach, which the Cookbook discusses only briefly. Furthermore, this chapter covers a range of topics, from the currently available emission factors and the possibility of improving them to a potential integration of community carbon monitoring with national carbon monitoring. This chapter is particularly recommended for people who wish a concise presentation of forest carbon measurements not covered by the Cookbook.				
National, Sub-national, Project					
<a href="http://www.cifor.org/online-library/browse/view-publication/publication/3805.html">http://www.cifor.org/online-library/browse/view-publication/publication/3805.html</a>					

No. 20	(A) Reporting on Climate Change Use manual for the guidelines on national communications from non-Annex I Parties (B) UNFCCC Resource Guide For Preparing The National Communications of Non-Annex I Parties. Module 3 National greenhouse Gas Inventories	EN FR SP	(A) 2004 (B) 2009	UNFCCC	
P05	Manual (A) was prepared to help non-Annex I countries develop a national communication (NC) based on information currently available. To ensure that the parties fully document all that needs to be reported, it provides detailed explanations and tips and points out relevant articles of the convention. In addition, for further explanation, four sets Resource Guides are available. The third guide (B) provides guidance on developing a national GHG inventory. Since REDD-plus rules are being negotiated, we don't know what countries should report or how they should structure the report. Nevertheless, these documents help us visualize what a national level report should look like.				
International, National					
<a href="http://unfccc.int/national_reports/non-annex_i_natcom/guidelines_and_user_manual/items/2607.php">http://unfccc.int/national_reports/non-annex_i_natcom/guidelines_and_user_manual/items/2607.php</a>					

No.21	IPCC Inventory Software	EN	2012	The IPCC Task Force on National Greenhouse Gas Inventories
P05	This software has been developed for supporting countries to develop a national GHG inventory (see recipe P05 in the Cookbook) and in a national communication for submission to the UNFCCC. This software's structure follows the Tier 1 and Tier 2 methodologies of 2006 IPCC Guidelines. Since default data for Tier 1 methodology has already been embedded in the software, users can use that data to perform a simulation. In addition, a user manual for the software can also be downloaded from the same website. Because specific reporting requirements have not yet been decided, this software will be useful for people who wish to begin planning the development of an inventory and the probable reporting requirements.			
International, National				
<a href="http://www.ipcc-nggip.iges.or.jp/software/index.html">http://www.ipcc-nggip.iges.or.jp/software/index.html</a>				

No. 22	8. Verification and Issuance. In: Building Forest Carbon Projects. Step-by-Step Overview and Guide	EN	2011	Olander & Ebeling	Forest Trends
P06	This guide is an introduction to verification and credit issuance at the project level (this guide is also in the 'Building Forest Carbon Projects' series introduced in No. 5). Because the UNFCCC has not agreed on the REDD-plus verification modality, this chapter explains basic steps for verification of GHG benefits from a project, the possible costs of verification, and the importance of the timing of the initial verification, giving examples of both VCS and CDM. In addition, it briefly describes the relationship between credit issuance and verification. This section of the guide will be useful for people who need information about the verification modality of REDD-plus at the project level.				
Project					
<a href="http://forest-trends.org/publication_details.php?publicationID=2555">http://forest-trends.org/publication_details.php?publicationID=2555</a>					

## Chapter 5: Monitoring by the stock change method

No. 23	Remote sensing and image interpretation Sixth Edition	EN	2007	Lillesand et al.	John Wiley & Sons, Inc.
P08	This book is the sixth edition (the first edition was published in 1979) of a well-known textbook on remote sensing and image interpretation that is used globally. The book is designed as a reference for practitioners who deal with geospatial information in various fields. Since the book is intended as a general textbook about remote sensing, it provides relatively little information specific to forest ecosystems. Nevertheless, it is highly recommended for people wish to acquire a fundamental understanding of the remote sensing topics introduced in P08 and Chapter 7, such as types of remote sensing data, selection of data, pre-processing of data, classification methods, and accuracy verification.				
National, Sub-national, Project					
Book available for purchase ISBN978-0470052457					

No. 24	Field Methods in Remote Sensing	EN	2005	MaCoy	Guilford Press
P08	<p>This book provides guidance on ground truthing methods used in remote sensing applications. It includes detailed explanations on project planning, sampling methods, steps for identifying locations in the field using a GPS, and various measurement methods. In particular, the explanations on the measurement methods of vegetation and on identifying and measuring various surface features, as well as the included field note forms, will be useful for people conducting field surveys for REDD-plus. This book will be of most benefit to people who have an understanding of remote sensing but little practical knowledge about ground truthing.</p>				
National, Sub-national, Project					
Book available for purchase ISBN978-1593850791					

No. 25	Carbon Inventory Methods: Handbook for Greenhouse Gas Inventory, Carbon Mitigation and Roundwood Production Projects	EN	2008	Ravindranath et al.	Springer
P04–P10	<p>This handbook on the development of forest carbon inventory was written by two experts in this arena, one of whom has been involved in the preparation of the IPCC guidelines. The handbook includes detailed explanations on the topics introduced in the Cookbook (P04–P10). In particular, it describes methods for measuring carbon pools that are not covered in detail in our Cookbook: below-ground biomass, dead wood, litter, and soil. This book is highly recommended for carbon inventory planners and people who will conduct field surveys. It should be a useful companion book to our Cookbook.</p>				
National, Sub-national, Project					
Book available for purchase ISBN978-1-4020-6546-0					

No. 26	Tropical Forest Census Plots	EN	1998	Condit	Springer-Verlag
P10	<p>This book gives detailed explanations on methods for establishing plots for large-scale ecological surveys in tropical forests. It includes a comprehensive description of the requirements of permanent sample plots (PSPs), introduced in the Cookbook, and provides tips on conducting plot surveys, including field survey methods and database development, ways of coping with problems that might arise during a survey, and scheduling and labor estimation for the survey. It also includes case studies about surveys in Barro Colorado Island, Panama, and 11 other large forest areas in the world. This handbook will be quite useful for planners involved in plot design and people conducting field surveys.</p>				
National, Sub-national, Project					
Book available for purchase ISBN978-3-540-64144-5					



No. 27	Winrock Terrestrial Sampling Calculator	EN	2007	Walker et al.	Winrock International
P10 T12	This Excel tool calculates the number of PSPs necessary for each forest type, based on Stratified Sampling (introduced in T12 of the Cookbook). The user enters the area of each forest type; the carbon stocks per unit area for each, with standard deviation; the plot size; and costs (e.g., of travel, equipment, sample analysis). The output is an estimate of the number of plots required and of the cost of conducting the sampling. This is a useful tool for obtaining a quick estimate of the number of plots needed and the costs of the sampling.				
National, Sub-national, Project					
<a href="http://www.winrock.org/ecosystems/tools.asp">http://www.winrock.org/ecosystems/tools.asp</a>					

No. 28	2.7 Estimation of Uncertainties. In: A sourcebook of methods and procedures for monitoring and reporting anthropogenic greenhouse gas emissions and removals associated with deforestation, gains and losses of carbon stocks in forests remaining forests, and forestation	EN	2012	GOFC-GOLD	GOFC-GOLD Project Office
P12	This chapter in the <i>GOFC-GOLD Sourcebook</i> explains how to estimate uncertainties in area and carbon stocks. It includes a brief explanation of the concept of 'uncertainties', requirements for estimating uncertainties in both area and carbon stocks, methods for combining these two uncertainties, and the reporting uncertainties. Helpful figures and tables make the material easier to understand. It also contains many useful references for further reading. This chapter will benefit not only to people who wish to go beyond the explanations in the Cookbook but also to people who are just learning the basic concepts related to uncertainties and the combining of uncertainties.				
National, Sub-national, Project					
<a href="http://www.gofcgold.wur.nl/redd/">http://www.gofcgold.wur.nl/redd/</a>					

No. 29	Guidelines for REDD+ Reference Levels: Principles and Recommendations	EN	2011	Angelsen et al.	Meridian Institute, The Gov. of Norway
P13	This 20-page report proposes guidelines for developing reference levels under the UNFCCC. It covers the selection of activity data and emission factors for reference level development and methods for analyzing the data. It also introduces the basic ideas and points to consider with regard to national circumstances and setting reference levels at sub-national level. Appendix 2 contains examples of reference level development in Brazil and Guiana. This report will be useful for policy makers and people who wish to understand the theory of reference level development at the national level with practical examples.				
National, Sub-national, Project					
<a href="http://www.forestcarbonportal.com/resource/guidelines-redd-reference-levels-principles-and-recommendations">http://www.forestcarbonportal.com/resource/guidelines-redd-reference-levels-principles-and-recommendations</a>					

## Index

AFOLU	I04, P04, T04	P05, P06, P13, T04
CDM	I03, P04	UN-REDD I01, P02, P03
	P05, P06, T12	VCS (Verified Carbon Standard)
CER (Certified Emission Reduction)	T04	I01, I03, P06, T04
CO <sub>2</sub> emission	I01, I02, P04, P13, T04	VCU (Verified Certification Units)
COP 13	I01, I02, I03, P01, P02	T04
COP 15	I01, I02, P13	VER I04, T04
COP 16	I01, I02, P03, P05, P13	above-ground biomass P04, P11, T02
COP 17	I01, I02, P03, P05, P13	T03, T14, T16, T19
DSM	T05, T16	accuracy I03, P05
DTM	T05	accuracy assessment T10
FAO	I01, I02, P10, T09, T11	airborne LiDAR P11, T05, T16
GOFC-GOLD	T11	allometric equation P10, T13, T14, T16
GPG	P05, P06	area changes I03, P04, P07, P08, T11
GPS	T05, T08, T13	area estimation P07, P08
GPS camera	T08	atmospheric correction P08
IPCC	I01, P04, P06, P07, T02, T14	backscattering coefficient P07, P09
IPCC guideline	I01, I02, I03, I04	P11, T19
	P05, P06, P07	bamboo P11, T13, T16, T17
J-VER	T04	basal area T14, T16
Landsat	P08, T05, T06, T09, T11, T19	below-ground biomass P04, T02, T14
LiDAR	P08, P11, T05, T16	Bilateral Offset Credit
LULUCF	P02, P05, P06	Mechanism (BOCM) I01, I04, T04
MRV	I01, I02, I03, P02	biodiversity I01, I02, P01
	P05, P06, P11, P13	P03, P06, T01
NFI	I04, P10, T01, T03	biomass expansion factor P10, T14
REDD-plus	I01, I02, I03, I04, P01, P02	buttress root T13
	P03, P04, P05, P06, P11	capacity building I02, I03, I04
	P13, T02, T03, T04, T13	P02, P04, P13
SAR	P07, P08, P09, P11, T05, T19	carbon credit I02, I03, P06
SBSTA	I01, I02, I03, P13	P12, P13, T04
UNFCCC	I01, I02, I03, I04,	carbon stocks I01, I02, I03, P01
	P01, P02, P03, P04	P04, P07, P09, P10

	P11, P12, P13, T01		
	T02, T03, T12, T13, T14	environment safeguard	P03
	T15, T16, T17, T18, T19	estimation model	
classes	P08, T07, T08, T09, T10, T11		P07, P09, P11, T03, T19
Clean Development Mechanism (CDM)		estimation of forest area	P08, T11
	I 02, I03, T04	field survey/measurement	I01, I02, I04
cloud removal	T06		P04, P07, P08, P10, P11, T03
cloud-free image	P08, T06		T08, T13, T15, T16, T18, T19
cluster	P08, T01, T09	flux method	T02
community age	P07, P09	Food and Agriculture Organization (FAO)	
	P11, T15, T18		I01
community age method	P11, T18	forest area	I02, I03, I04
comparability	I03, I04, P05		P01, P04, P07, T03
completeness	I03, I04, P04, P05	Forest Carbon Partnership Facility (FCPF)	
Conference of the Parties	I04, P05		I01, P02, P03
consistency	I03, I04, P05	forest conservation	I01, I02, P06, T04
Copenhagen Accord	I01, I03	forest degradation	I01, I02, I04, P01
corporate social responsibility (CSR)			P02, P03, P06, P09
	T04		P11, P13, T05, T12, T18
credit (credits)	I01, I02, I03, I04, P03	forest monitoring	I01, I02, I03, I04
	P04, P06, P12, P13, T04	forest planning	P02
credit mechanism	I03, T04	Forest Resources Assessment (FRA)	
cross-polarized (HV, VH) wave	T19		I02, T09, T11
crown diameter	P07, P09, P11, T15, T17	forest type	I04, P04, P07, P08
crown diameter method	P11, T17		P09, P10, P11, P12
deforestation	I01, I02, I04, P01, P02		T04, T05, T06, T 07
	P06, P09, P11, P13, T05, T19		T12, T14, T16, T17, T19
diameter at breast height	P10, T01	Fourth Assessment Report (AR4)	I01
	T13, T14, T17	framework convention on	
tree height curve	T13, T17	climate change (UNFCCC)	I01
double sampling	T15	gain-loss method	P04, P07
emission reduction	I02, I03, I04	geometric correction/ registration	
	P01, P02, P05, P06, T04		P08, T11, T17

girth at breast height	T13		P05, P06, P13
greenhouse gas	I01, I02, I03, I04	multiple reflection	P11
	P04, P05, P06, T02	multi-layer image	T11
ground truth	P08, T08, T09, T10	National Forest Inventory (NFI)	
haze	T05, T06		I04, P09, P10, T01, T03, T10, T13
illegal logging	I02	national forest monitoring system	
Intergovernmental Panel on			I01, I02, I04
Climate Change (IPCC)	I01	national greenhouse gas inventory	
International Organization			I03, I04, P06
for Standardization (ISO)	P06	National Inventory Report (NIR)	P05
inventory	I01, I03, I04, P04	national level	I02, I03, I04, P05
	P05, P06, P07, P09		P07, P08, P09, P10
	P10, P11, T01, T10, T13		P13, T04, T12, T14, T18
kappa coefficient	P08, T10	speckle noise	T19
Kyoto Protocol	I01, I02, P01	object-based	T11
	P02, P05, T04	object-based classification	
land cover	P07, P08, T05, T06, T07		P08, T09, T11
	T08, T09, T10, T11	oil palm	T13, T18
land surface condition	P11	optical sensor	P08, P11
land use	I01, I02, I03, I04		T03, T05, T16
	P02, P04, P07, P09, P11, P13	overstory height	
	T04, T09, T12, T13, T18		P07, P09, P11, T15, T16
laser pulse	T05	overstory height method	P11, T16
like-polarized wave	T19	parameter	P05, P06, P07, P09
Marrakesh accords	P01		P11, T01, T09, T15, T16
measurement	I01, I02, I03, I04, P02	Permanent Sample Plot (PSP)	
	P04, P06, P07, P09, P10		P07, P09, P10, P11, T03
	P11, P12, P13, T01, T02, T05		T12, T13, T14, T15, T17
	T08, T13, T15, T16, T17, T19	phased approach	I01, I02, I03
measurement reporting and verification			I04, P02, P04, P13
	I01, I02, I03, P02, P11	pixel	P08, T09, T10, T11, T19
microwave	P11, T05, T19	platform	T05
modality/modalities	I01, I03		

Polarimetric Interferometry		stratified sampling	P08, P10, T08
SAR (POLinSAR)	P11		T10, T12
producer's accuracy	P08, T10	sub-national level	I01, I02, I03, I04
project level	I01, I02, I03, I04, P05, P06		P02, P06, P07
reference emission level	I01, I02, I04		P13, T04, T18
	P12, P13	supervised classification	P08, T09
reference level	I01, I02, I04, P02	sustainable management of forests	
	P06, P12, P13		I01, I02, P01
remote sensing	I01, I02, I04, P04, P06	Synthetic Aperture Radar (SAR)	
	P07, P08, P10, P11, P13		P07, P08, P11, T05, T19
	T03, T05, T07, T09, T10	temporal resolution	P08, T05
	T11, T13, T15, T16, T17, T19	Third Assessment Report (TAR)	I01
remote sensing data	P07, P08, P10	overall accuracy	P08, T10
	T07, T08, T15, T16, T17	transparency	I02, I03, I04, P05, P13
reporting	I01, I02, I03, I04	tree census	P11, T13, T14, T15, T18
	P02, P05, P11	tree crown cover	I02, P01
rubber	P11, T13, T18	uncertainty	I03, P04, P06, P07, P12, T10
safeguard	I01, I02, I03, I04	U. N. Development Programme (UNDP)	I01
	P02, P03, P06	U. N. Environment Programme (UNEP)	I01
sampling design	P07, T01, T10, T15	unsupervised classification	P08, T09
seasonality	T06	user's accuracy	P08, T10
sensor	P08, P11, T03, T05	verification data	P08
	T15, T16, T17, T19	Verified Emission Reduction credit	I04
slash-and-burn	P11, T18, T19	wavelength resolution	T03, T05
social safeguard	P03		
software	P08, P12, T05		
space-borne LiDAR	T16		
spatial resolution	T05, T07		
stand carbon stock estimation model			
	P07, P09, P11		
stereoscopic sensors/ images(information)	P11, T16		
stock change method	P04, P07, P09		
	P12, T02		

## Authors

Shinichi Aikawa <sup>1)</sup>	Reference Guide	Kei Suzuki <sup>6)</sup>	Recipe T03
Satoshi Akahori <sup>5)</sup>	Recipe P02	Gen Takao <sup>1)</sup>	Recipe I04, P04, T10, T15
Yoshio Awaya <sup>2)</sup>	Recipe T19	Shinya Tanaka <sup>1)</sup>	Recipe T09
Makoto Ehara <sup>1)</sup>	Recipe P03, Reference Guide	Takeshi Toma <sup>1)</sup>	Recipe P01, T03, Reference Guide
Yasumasa Hirata <sup>1)</sup>	Recipe I02, P13	Jumpei Toriyama <sup>1)</sup>	Recipe P12, T02
Naoyuki Furuya <sup>1)</sup>	Recipe T17	Naoko Tsukada <sup>1)</sup>	Recipe P05, P06
Kimihiko Hyakumura <sup>3)</sup>	Recipe P03	Satoshi Tsuyuki <sup>4)</sup>	Recipe T05
Toshiro Iehara <sup>1)</sup>	Recipe T01	Mitsuo Matsumoto <sup>1)</sup>	Recipe I01, T04
Eriko Ito <sup>1)</sup>	Recipe P11, T16	Toshiya Matsuura <sup>1)</sup>	Recipe T08
Tsuyoshi Kajisa <sup>3)</sup>	Recipe T11	Nobuya Mizoue <sup>3)</sup>	Recipe P10, T12
Satoko Kawarasaki <sup>1)</sup>	Reference Guide	Yukako Monda <sup>1)</sup>	Recipe P09, T14
Yoshiyuki Kiyono <sup>1)</sup>	Recipe I03	Tetsushi Ohta <sup>3)</sup>	Recipe T07
Hideki Saito <sup>1)</sup>	Recipe P08, T06	Yasuhiro Yokota <sup>1)</sup>	Recipe P03
Akinobu Sato <sup>6)</sup>	Recipe T03		
Tamotsu Sato <sup>1)</sup>	Recipe P07, T13, T18		

1) Forestry and Forest Products Research Institute, Japan

2) Gifu University, Japan

3) Kyusyu University, Japan

4) The University of Tokyo, Japan

5) Forestry Agency, Ministry of Agriculture, Forestry and Fisheries, Japan

6) Japan Forest Technology Association

## Editors

Yasumasa Hirata • Gen Takao • Tamotsu Sato • Jumpei Toriyama

## Editorial staff

Makoto Araki • Yasumasa Hirata • Gen Takao • Tamotsu Sato

Jumpei Toriyama • Naoko Tsukada • Tomomi Fukumi • Atsuko Naka

## Citation

This document may be cited as:

Hirata Y, Takao G, Sato T, Toriyama J (eds) (2012) REDD-plus Cookbook. REDD Research and Development Center, Forestry and Forest Products Research Institute Japan, 156pp. ISBN 978-4-905304-15-9

A digital copy of this report can be downloaded at <http://www.ffpri.affrc.go.jp/redd-rdc/en/reference/cookbook.html>





Forestry and Forest Products Research Institute  
1 Matsunosato, Tsukuba, Ibaraki, 305-8687 JAPAN  
REDD Research and Development Center  
TEL: +81-29-829-8365 FAX: +81-29-829-8366  
URL: <http://www.ffpri.affrc.go.jp/redd-rdc/ja/index.html>  
E-mail: [redd-rd-center@ffpri.affrc.go.jp](mailto:red-d-center@ffpri.affrc.go.jp)